

A

B

C

D

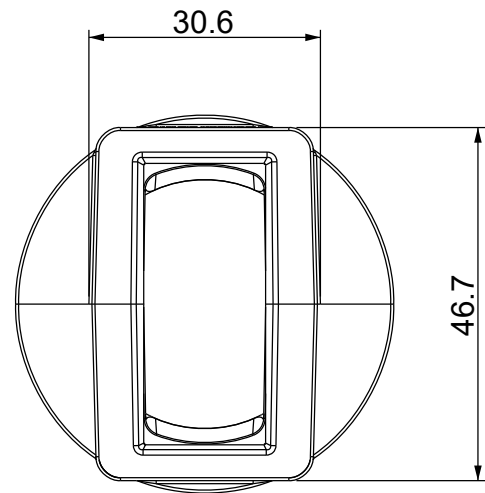
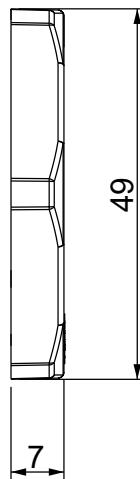
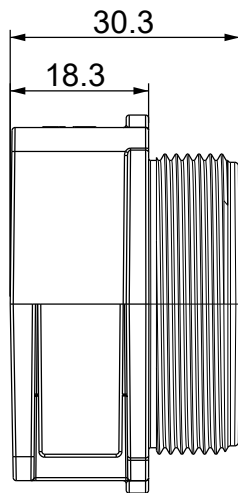
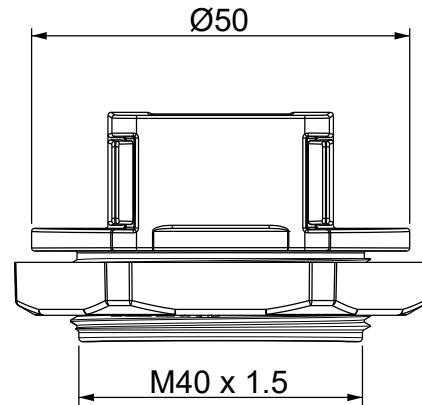
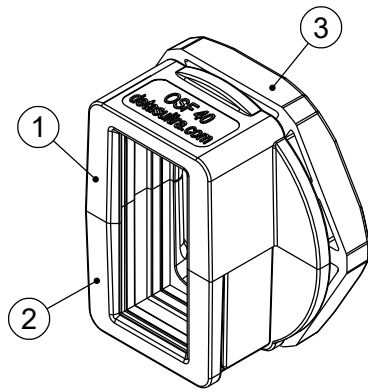

Id	Description	Material	Q.ty
1	OSF 40 Top	PC	1
2	OSF 40 Bottom	PC	1
3	M40 Locknut	PA	1
4	Gasket (not shown)	NBR	1

	IP54	NEMA 12	UL TYPE 12					IK10
--	-------------	----------------	-------------------	--	--	--	--	-------------

Flammability: UL94-V0, self-extinguishing
Temperature: -40°C ... +130°C
Properties: halogen-free, silicone-free

Recommended cut-out:
 Ø40.5mm

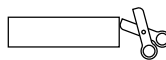

GREY color version:
 1731052340 OSF 40G

Codice / Code

1731052440

Descrizione / Description

OSF 40B

Rev.
 002

Materiale / Material
 see table

Colore / Color
 Black

Peso / Weight (g)
 -

Unità di misura / Measure units
 mm

Formato / Format
 A4

Scala / Scale
 1:1



Data / Date
 24/02/2021

Numero foglio / Sheet number
 -

Numero progetto / Project number
 -

Disegn. / Drawn
 ravezzano@detas.com

Note / Notes
 -

QUESTO DISEGNO E LE SUE INFORMAZIONI SONO STRETTAMENTE RISERVATE DI PROPRIETÀ DETAS SPA.
 NON UTILIZZARE PER SCOPI DIVERSI DA QUELLI PER CUI SONO STATE FORNITE. DO NOT SCALE DRAWING.

A

B

C

D