

A

B

C

D

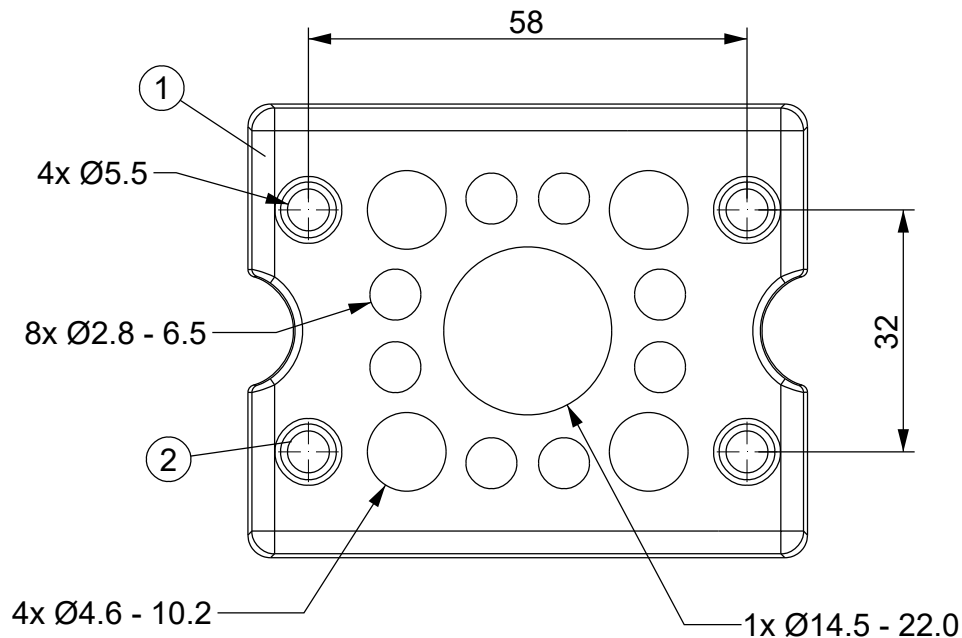
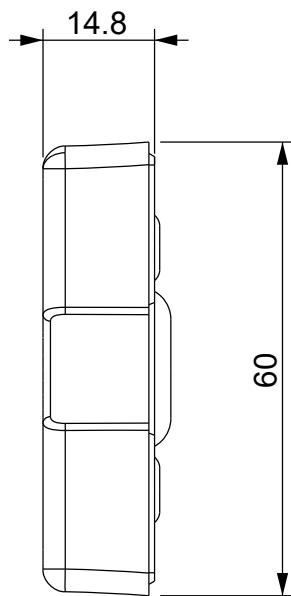
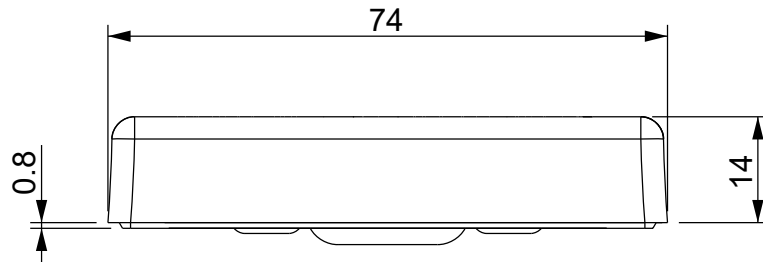
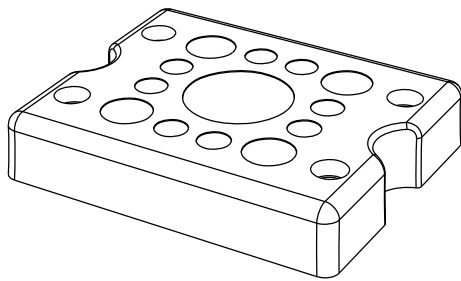

Black color version:  
DES-PDM-Q/13B: 1732015614

ATEX grey version:  
DES-PDM-QA/13G: 1732314613

ATEX black version:  
DES-PDM-QA/13B: 1732315614

Id	Description	Material	Q.ty
1	Body	TPE	1
2	Internal frame	PA	1

**Flammability:** UL94-V0, self-extinguishing  
**Temperature:** -40°C ... +105°C  
**Properties:** halogen-free, silicone-free

Recommended cut-out:  
46 x 46 mm

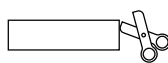

Codice / Code

1732014613

Descrizione / Description

DES PDM Q13G

Rev.  
001

Materiale / Material  
see table

Colore / Color  
Grey

Peso / Weight (g)  
-

Unità di misura / Measure units  
mm

Formato / Format  
A4

Scala / Scale  
1:1



Data / Date  
16/03/2021

Numero foglio / Sheet number  
-

Numero progetto / Project number  
-

Disegn. / Drawn  
ravezzano@detas.com

Note / Notes  
-

QUESTO DISEGNO E LE SUE INFORMAZIONI SONO STRETTAMENTE RISERVATE DI PROPRIETÀ DETAS SPA. NON UTILIZZARE PER SCOPI DIVERSI DA QUELLI PER CUI SONO STATE FORNITE. DO NOT SCALE DRAWING.

A

B

C

D

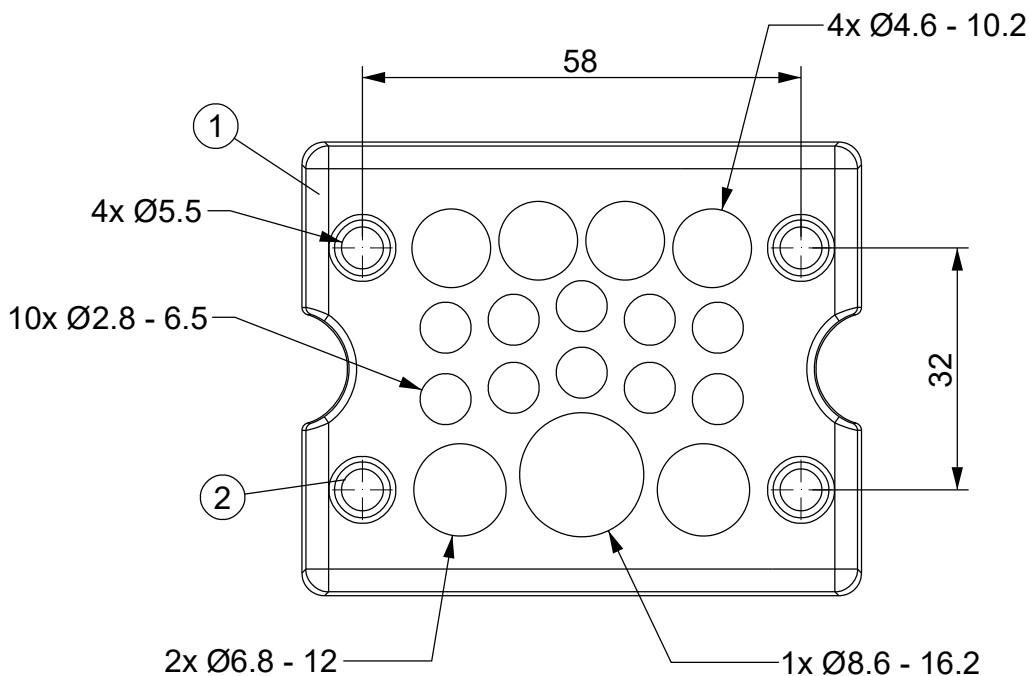
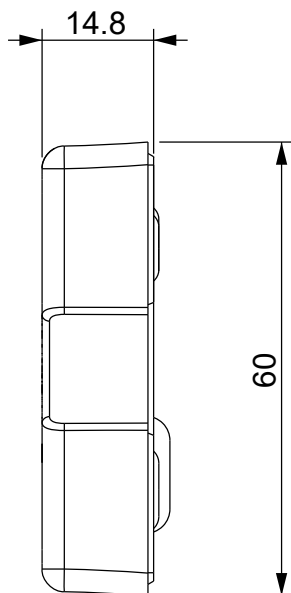
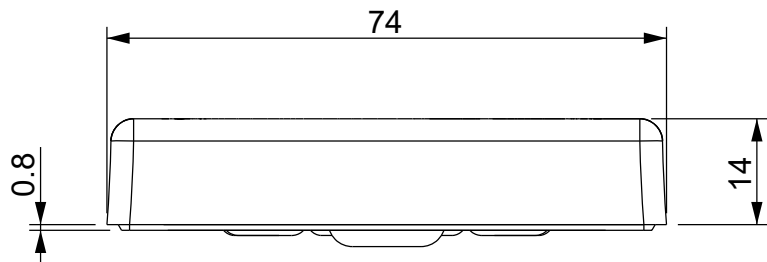
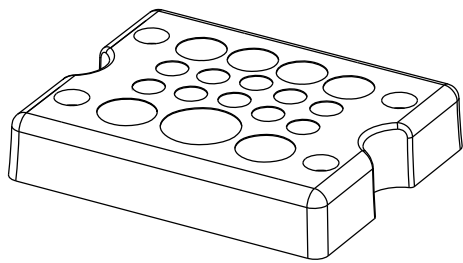

Black color version:  
DES-PDM-Q/17B: 1732015618

ATEX grey version:  
DES-PDM-QA/17G: 1732314617

ATEX black version:  
DES-PDM-QA/17B: 1732315618

Id	Description	Material	Q.ty
1	Body	TPE	1
2	Internal frame	PA	1

**Flammability:** UL94-V0, self-extinguishing  
**Temperature:** -40°C ... +105°C  
**Properties:** halogen-free, silicone-free

Recommended cut-out:  
46 x 46 mm

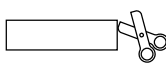

Codice / Code

1732014617

Descrizione / Description

DES PDM Q17G

Rev.  
001

Materiale / Material  
see table

Colore / Color  
Grey

Peso / Weight (g)  
-

Unità di misura / Measure units  
mm

Formato / Format  
A4

Scala / Scale  
1:1



Data / Date  
16/03/2021

Numero foglio / Sheet number  
-

Numero progetto / Project number  
-

Disegn. / Drawn  
ravezzano@detas.com

Note / Notes  
-

QUESTO DISEGNO E LE SUE INFORMAZIONI SONO STRETTAMENTE RISERVATE DI PROPRIETA' DETAS SPA. NON UTILIZZARE PER SCOPI DIVERSI DA QUELLI PER CUI SONO STATE FORNITE. DO NOT SCALE DRAWING.

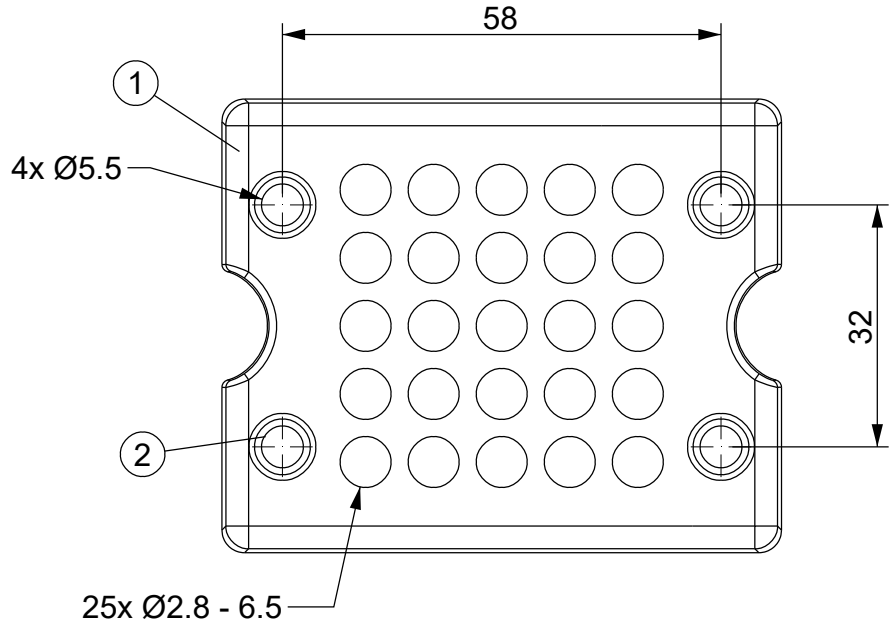
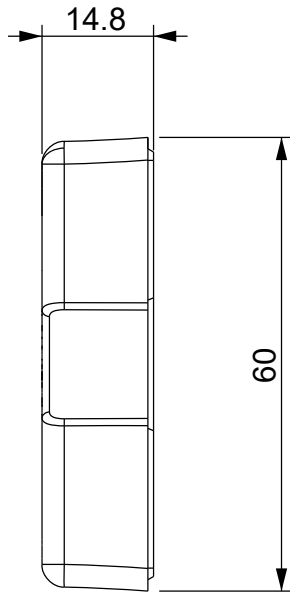
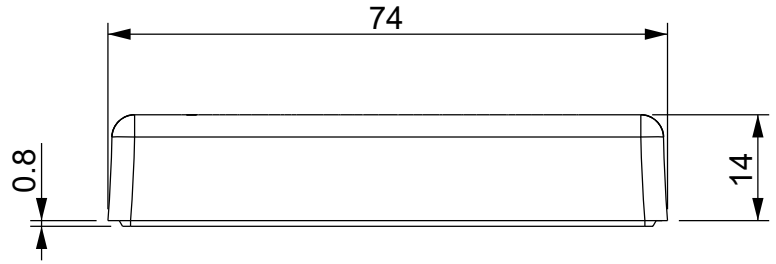
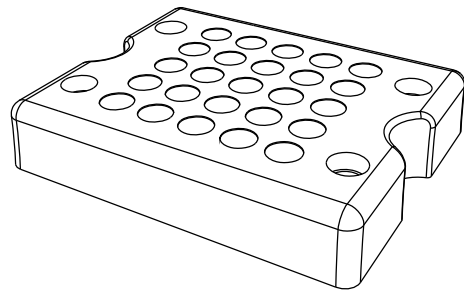

Black color version:  
DES-PDM-Q/25B: 1732015626

ATEX grey version:  
DES-PDM-QA/25G: 1732314625

ATEX black version:  
DES-PDM-QA/25B: 1732315626

Id	Description	Material	Q.ty
1	Body	TPE	1
2	Internal frame	PA	1

**Flammability:** UL94-V0, self-extinguishing  
**Temperature:** -40°C ... +105°C  
**Properties:** halogen-free, silicone-free

Recommended cut-out:  
46 x 46 mm

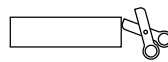

Codice / Code

1732014625

Descrizione / Description

DES PDM Q25G

Rev.  
001

Materiale / Material  
see table

Colore / Color  
Grey

Peso / Weight (g)  
-

Unità di misura / Measure units  
mm

Formato / Format  
A4

Scala / Scale  
1:1



Data / Date  
16/03/2021

Numero foglio / Sheet number  
-

Numero progetto / Project number  
-

Disegn. / Drawn  
ravezzano@detas.com

Note / Notes  
-

QUESTO DISEGNO E LE SUE INFORMAZIONI SONO STRETTAMENTE RISERVATE DI PROPRIETA' DETAS SPA. NON UTILIZZARE PER SCOPI DIVERSI DA QUELLI PER CUI SONO STATE FORNITE. DO NOT SCALE DRAWING.