

10x Ø2.8 - 6.5

Id	Description	Material	Q.ty
1	Body	TPE	1
2	Internal frame	PA	1

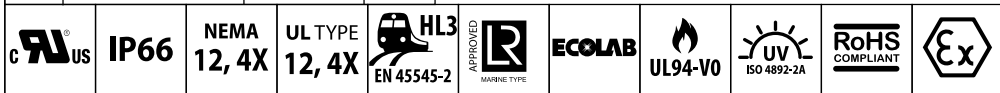

Flammability: UL94-V0, self-extinguishing
Temperature: -40°C ... +105°C
Properties: halogen-free, silicone-free

Recommended cut-out:
112 x 36 mm

Black color version:
DES-PDM-24/14B: 1732013415

Threaded inserts version:
DES-PDM-24/14G FT: 1732212414

ATEX grey version:
DES-PDM-24A/14G: 1732312414

ATEX black version:
DES-PDM-24A/14B: 1732313414

Codice / Code 1732012414			Descrizione / Description DES PDM 24/14			Rev. 003
Materiale / Material See table	Colore / Color Grey	Peso / Weight (g) -	Unità di misura / Measure units mm	Formato / Format A4	Scala / Scale 1:1	
 www.detasultra.com <small>QUESTO DISEGNO E LE SUE INFORMAZIONI SONO STRETTAMENTE RISERVATE DI PROPRIETÀ DETAS SPA. NON UTILIZZARE PER SCOPI DIVERSI DA QUELLI PER CUI SONO STATE FORNITE. DO NOT SCALE DRAWING.</small>			Data / Date 22/11/2021	Numero foglio / Sheet number -	Numero progetto / Project number -	
			Disegn. / Drawn ravezzano@detas.com	Note / Notes -		

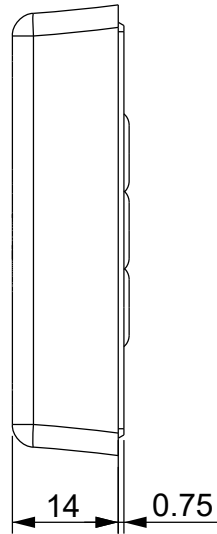
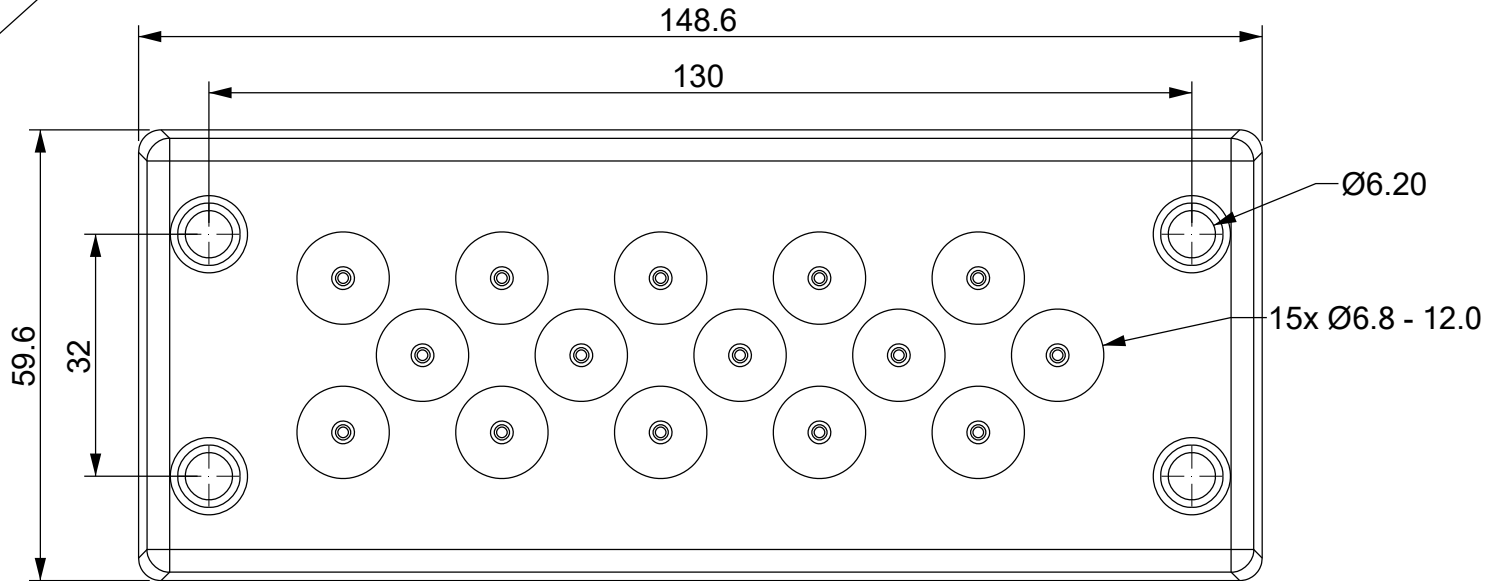
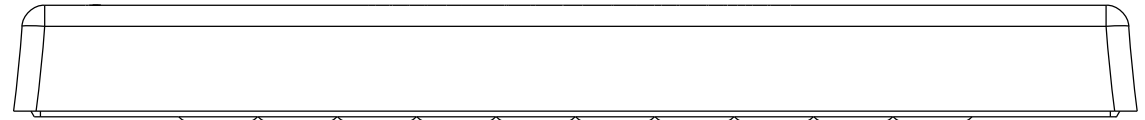
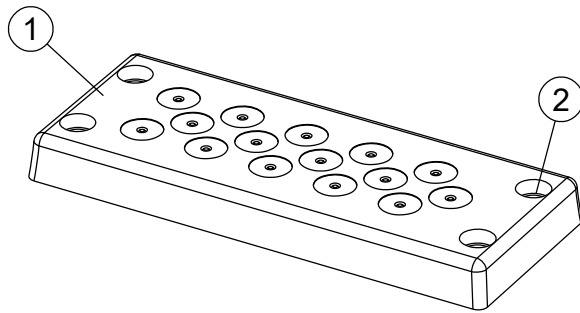

Id	Description	Material	Q.ty
1	Body	TPE	1
2	Internal frame	PA	1

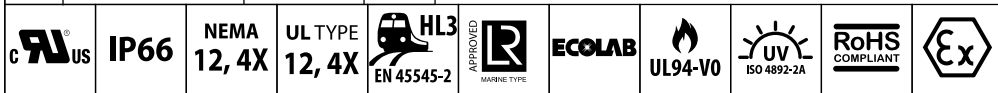

Flammability: UL94-V0, self-extinguishing
Temperature: -40°C ... +105°C
Properties: halogen-free, silicone-free

Recommended cut-out:
112 x 36 mm

Black color version: DES-PDM-24/15B: 1732013416 Threaded inserts version: DES-PDM-24/15G FT: 1732212415 ATEX grey version: DES-PDM-24A/15G: 1732312415 ATEX black version: DES-PDM-24A/15B: 1732313415	Codice / Code		Descrizione / Description			Rev.
	1732012415		DES PDM 24/15			003
	Materiale / Material	Colore / Color	Peso / Weight (g)	Unità di misura / Measure units	Formato / Format	Scala / Scale
See table	Grey	-	mm	A4	1:1	
 www.detasultra.com <small>QUESTO DISEGNO E LE SUE INFORMAZIONI SONO STRETTAMENTE RISERVATE DI PROPRIETÀ DETAS SPA. NON UTILIZZARE PER SCOPI DIVERSI DA QUELLI PER CUI SONO STATE FORNITE. DO NOT SCALE DRAWING.</small>			Data / Date	Numero foglio / Sheet number	Numero progetto / Project number	
			22/11/2021	-	-	
			Disegn. / Drawn	Note / Notes		
			ravezzano@detas.com	-		

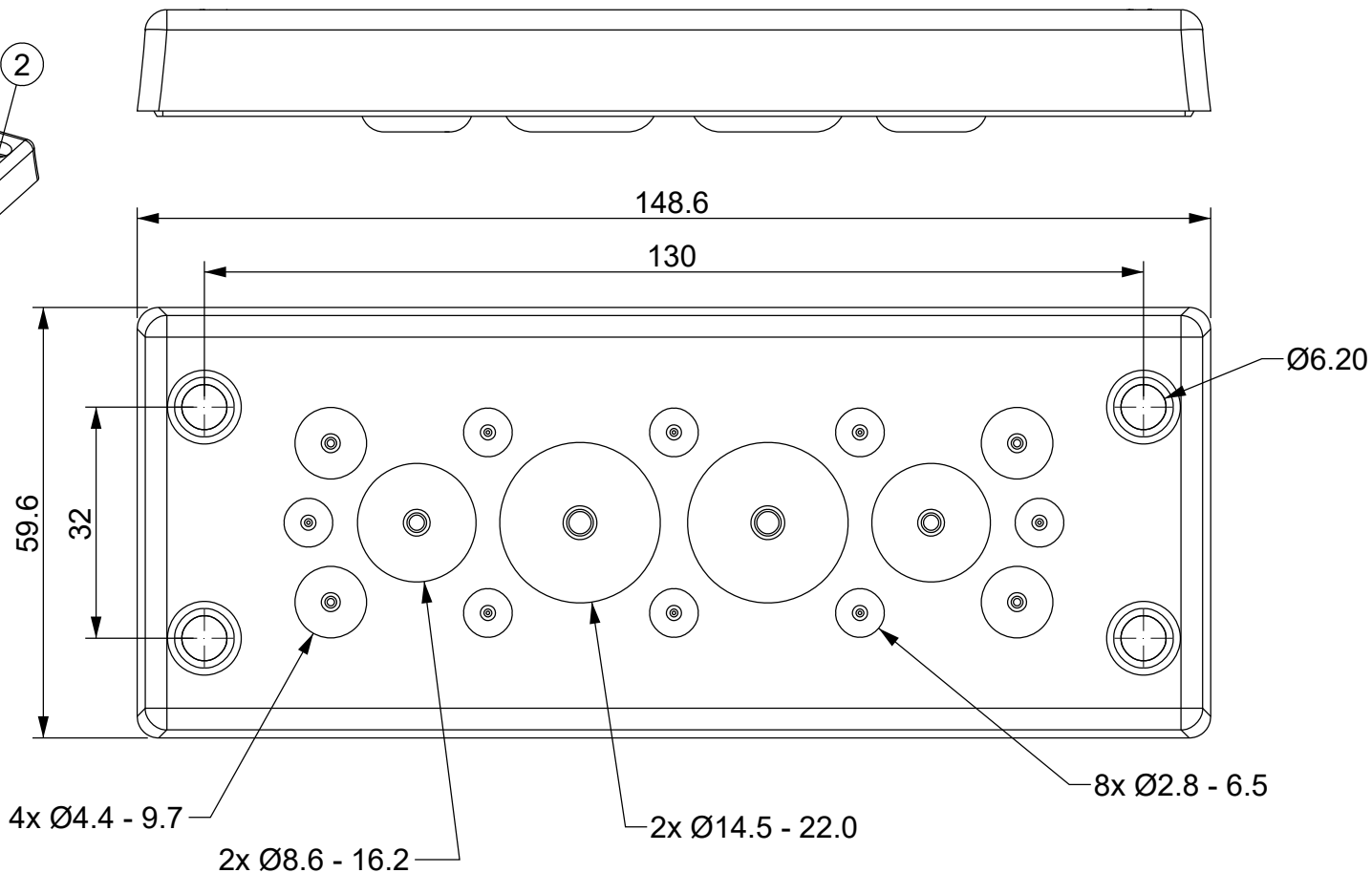
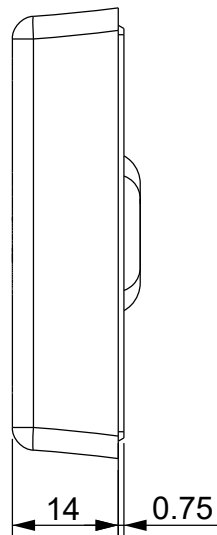
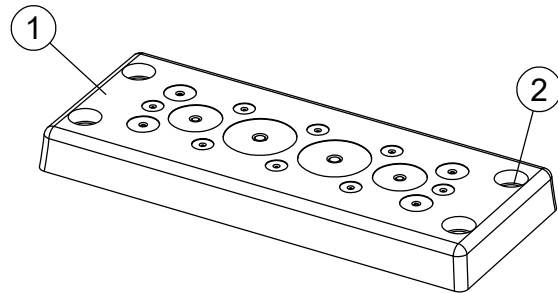

Id	Description	Material	Q.ty
1	Body	TPE	1
2	Internal frame	PA	1

Flammability: UL94-V0, self-extinguishing
Temperature: -40°C ... +105°C
Properties: halogen-free, silicone-free

Recommended cut-out: 112 x 36 mm

Black color version: DES-PDM-24/16B: 1732013417 Threaded inserts version: DES-PDM-24/16G FT: 1732212416 ATEX grey version: DES-PDM-24A/16G: 1732312416 ATEX black version: DES-PDM-24A/16B: 1732313416	Codice / Code		Descrizione / Description			Rev.
	1732012416		DES PDM 24/16			003
	Materiale / Material	Colore / Color	Peso / Weight (g)	Unità di misura / Measure units	Formato / Format	Scala / Scale
See table	Grey	-	mm	A4	1:1	
 www.detasultra.com <small>QUESTO DISEGNO E LE SUE INFORMAZIONI SONO STRETTAMENTE RISERVATE DI PROPRIETÀ DETAS SPA. NON UTILIZZARE PER SCOPI DIVERSI DA QUELLI PER CUI SONO STATE FORNITE. DO NOT SCALE DRAWING.</small>			Data / Date	Numero foglio / Sheet number	Numero progetto / Project number	
			22/11/2021	-	-	
			Disegn. / Drawn	Note / Notes		
			ravezzano@detas.com	-		

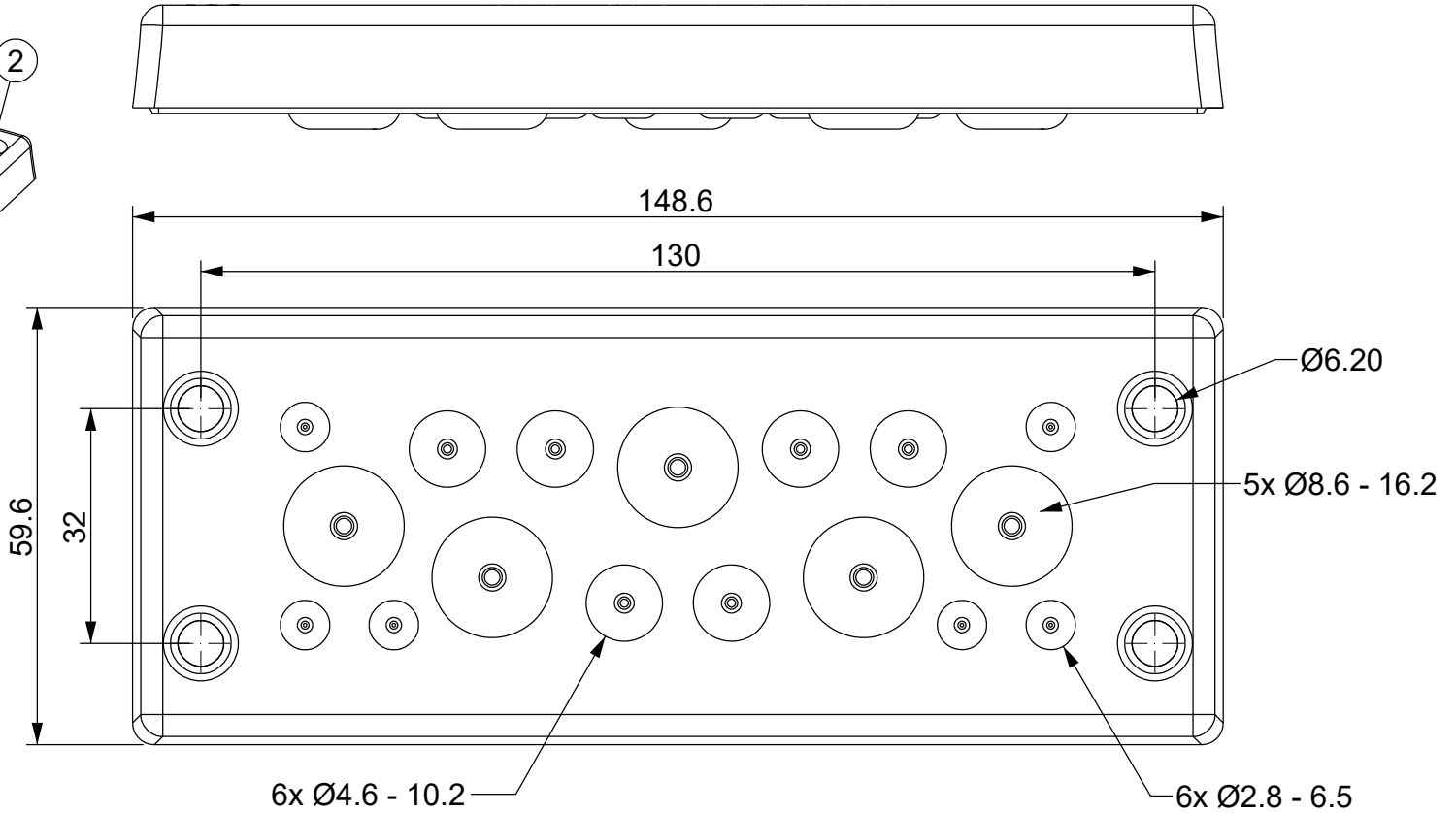
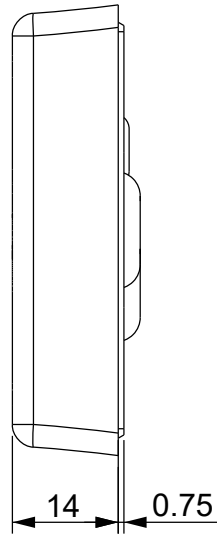
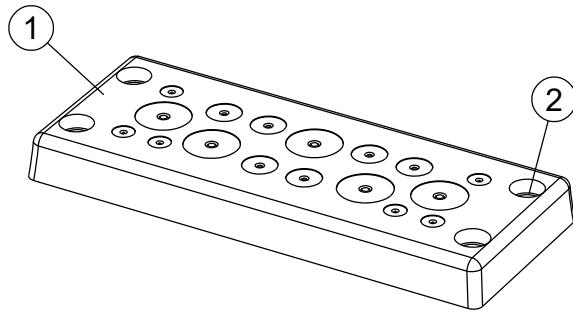

Id	Description	Material	Q.ty
1	Body	TPE	1
2	Internal frame	PA	1

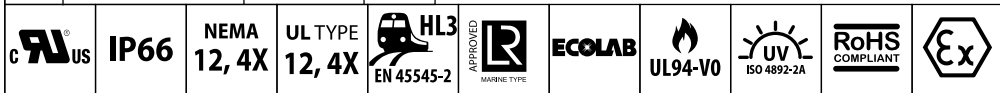

Flammability: UL94-V0, self-extinguishing
Temperature: -40°C ... +105°C
Properties: halogen-free, silicone-free

Recommended cut-out:
112 x 36 mm

Black color version: DES-PDM-24/17B: 1732013418 Threaded inserts version: DES-PDM-24/17G FT: 1732212417 ATEX grey version: DES-PDM-24A/17G: 1732312417 ATEX black version: DES-PDM-24A/17B: 1732313417	Codice / Code		Descrizione / Description			Rev.
	1732012417		DES PDM 24/17			003
	Materiale / Material	Colore / Color	Peso / Weight (g)	Unità di misura / Measure units	Formato / Format	Scala / Scale
See table	Grey	-	mm	A4	1:1	
 www.detasultra.com <small>QUESTO DISEGNO E LE SUE INFORMAZIONI SONO STRETTAMENTE RISERVATE DI PROPRIETÀ DETAS SPA. NON UTILIZZARE PER SCOPI DIVERSI DA QUELLI PER CUI SONO STATE FORNITE. DO NOT SCALE DRAWING.</small>			Data / Date	Numero foglio / Sheet number	Numero progetto / Project number	
			22/11/2021	-	-	
			Disegn. / Drawn	Note / Notes		
			ravezzano@detas.com	-		

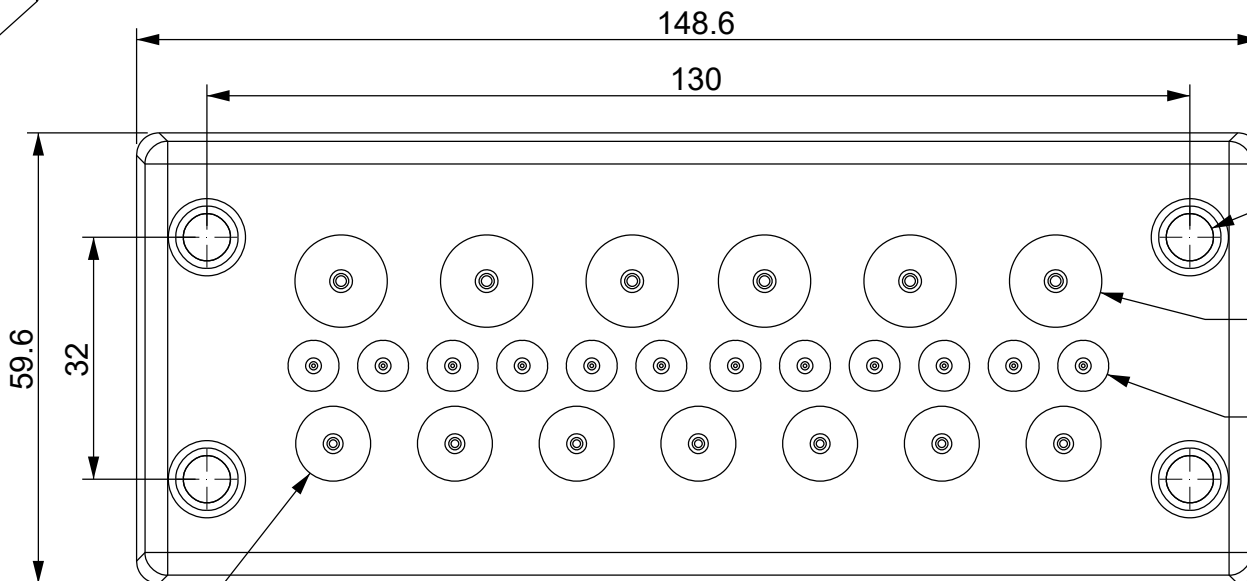
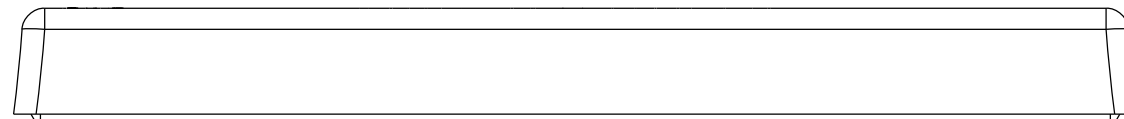
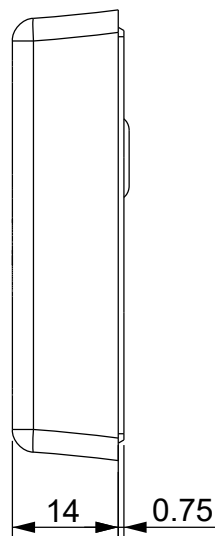
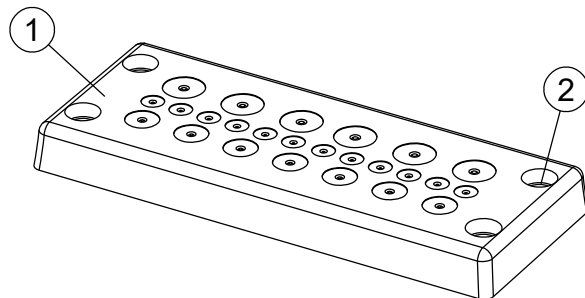

7x Ø4.4 - 9.7

Ø6.20

6x Ø6.8 - 12.0

12x Ø2.8 - 6.5

Id	Description	Material	Q.ty
1	Body	TPE	1
2	Internal frame	PA	1

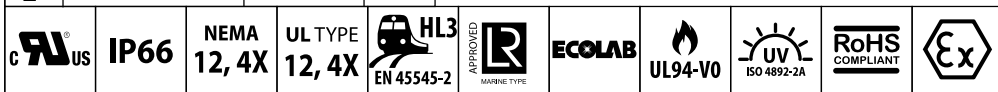

Flammability: UL94-V0, self-extinguishing
Temperature: -40°C ... +105°C
Properties: halogen-free, silicone-free

Recommended cut-out:
112 x 36 mm

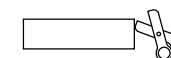

Black color version:
DES-PDM-24/25B: 1732013426

Threaded inserts version:
DES-PDM-24/25G FT: 1732212425

ATEX grey version:
DES-PDM-24A/25G: 1732312425

ATEX black version:
DES-PDM-24A/25B: 1732313425

Codice / Code

1732012425

Descrizione / Description

DES PDM 24/25

Rev.

003

Materiale / Material

See table

Colore / Color

Grey

Peso / Weight (g)

-

Unità di misura / Measure units

mm

Formato / Format

A4

Scala / Scale

1:1



QUESTO DISEGNO E LE SUE INFORMAZIONI SONO STRETTAMENTE RISERVATE DI PROPRIETÀ DETAS SPA.
NON UTILIZZARE PER SCOPI DIVERSI DA QUELLI PER CUI SONO STATE FORNITE. DO NOT SCALE DRAWING.

Data / Date

22/11/2021

Numero foglio / Sheet number

-

Numero progetto / Project number

-

Disegn. / Drawn

ravezzano@detas.com

Note / Notes

-

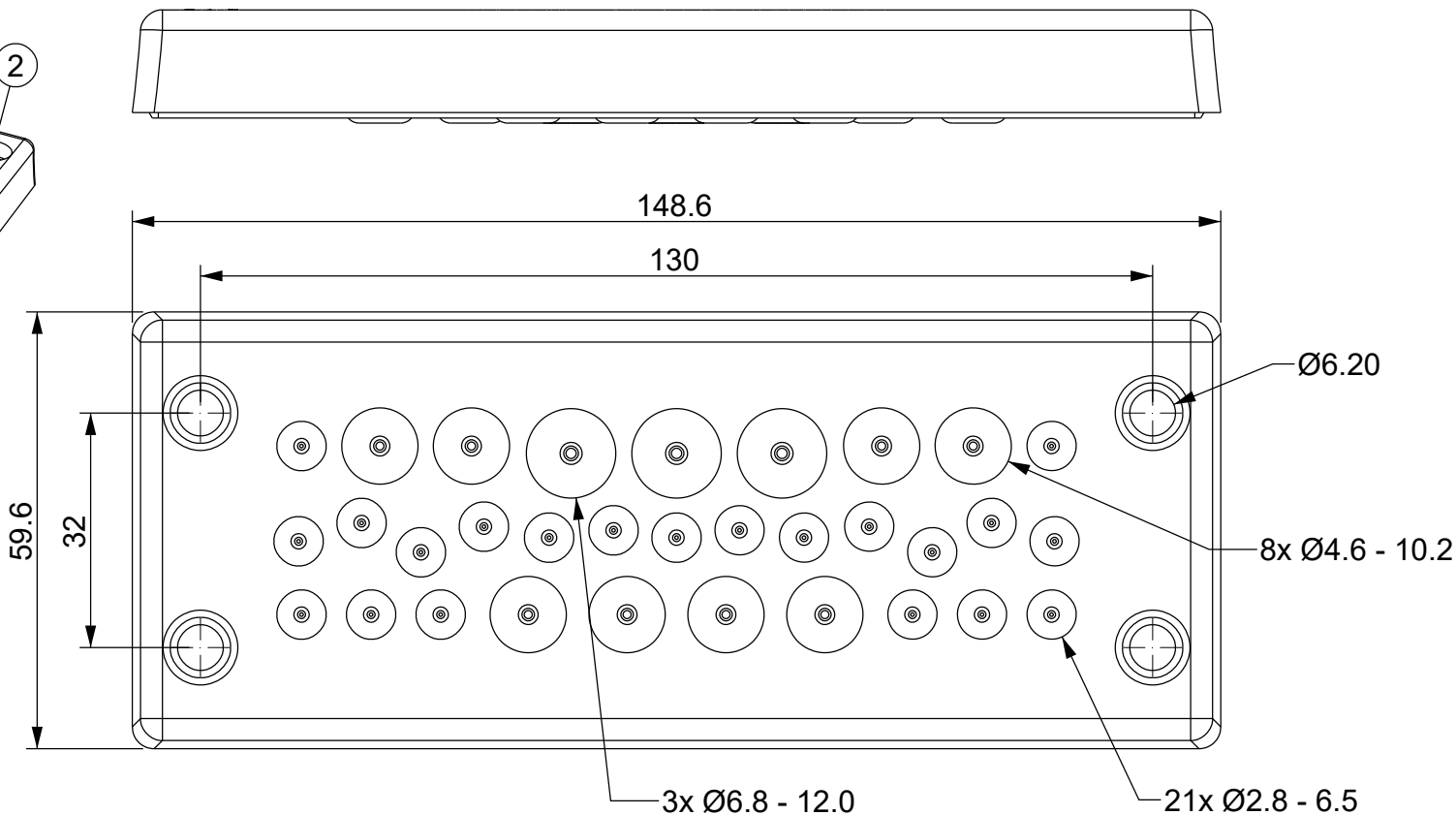
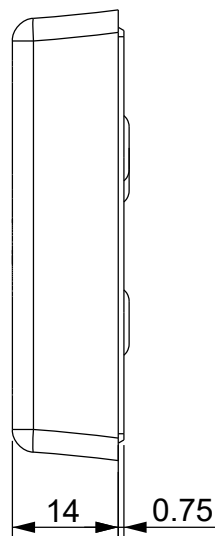
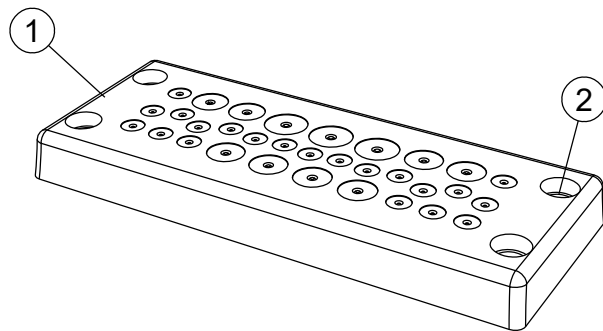

Id	Description	Material	Q.ty
1	Body	TPE	1
2	Internal frame	PA	1

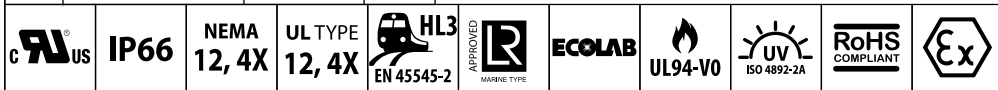

Flammability: UL94-V0, self-extinguishing
Temperature: -40°C ... +105°C
Properties: halogen-free, silicone-free

Recommended cut-out:
112 x 36 mm

Black color version: DES-PDM-24/32B: 1732013433 Threaded inserts version: DES-PDM-24/32G FT: 1732212432 ATEX grey version: DES-PDM-24A/32G: 1732312432 ATEX black version: DES-PDM-24A/32B: 1732313432	Codice / Code		Descrizione / Description			Rev.
	1732012432		DES PDM 24/32			003
	Materiale / Material	Colore / Color	Peso / Weight (g)	Unità di misura / Measure units	Formato / Format	Scala / Scale
See table	Grey	-	mm	A4	1:1	
 www.detasultra.com <small>QUESTO DISEGNO E LE SUE INFORMAZIONI SONO STRETTAMENTE RISERVATE DI PROPRIETÀ DETAS SPA. NON UTILIZZARE PER SCOPI DIVERSI DA QUELLI PER CUI SONO STATE FORNITE. DO NOT SCALE DRAWING.</small>			Data / Date	Numero foglio / Sheet number	Numero progetto / Project number	
			22/11/2021	-	-	
			Disegn. / Drawn	Note / Notes		
			ravezzano@detas.com	-		

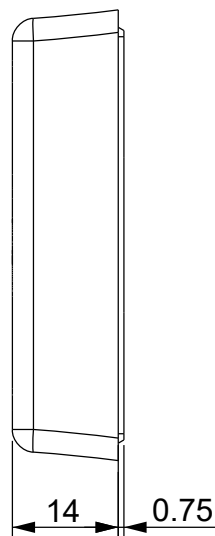
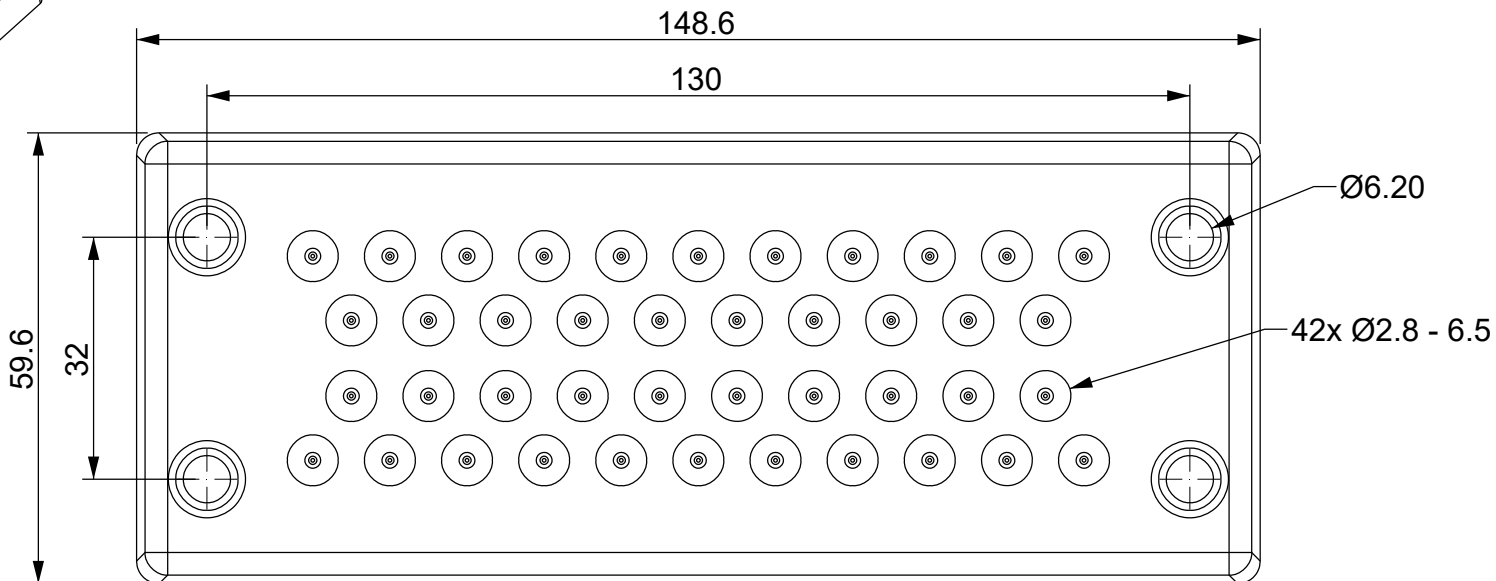
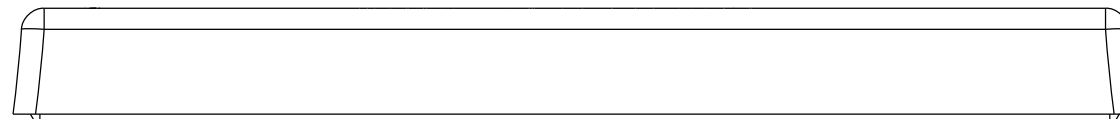
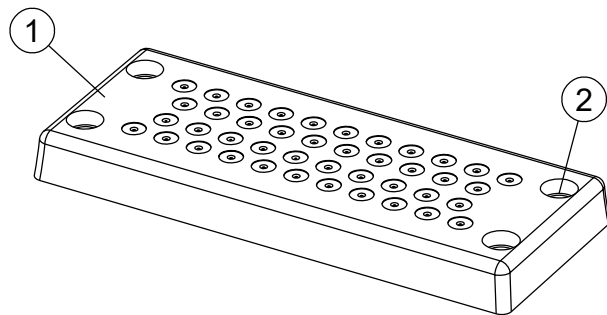

Id	Description	Material	Q.ty
1	Body	TPE	1
2	Internal frame	PA	1

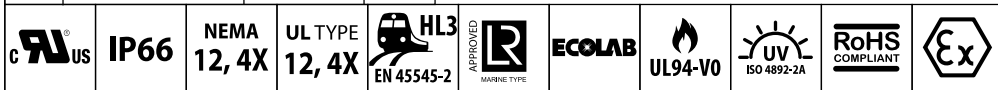

Flammability: UL94-V0, self-extinguishing
Temperature: -40°C ... +105°C
Properties: halogen-free, silicone-free

Recommended cut-out:
112 x 36 mm

Black color version: DES-PDM-24/42B: 1732013443 Threaded inserts version: DES-PDM-24/42G FT: 1732212442 ATEX grey version: DES-PDM-24A/42G: 1732312442 ATEX black version: DES-PDM-24A/42B: 1732313442	Codice / Code		Descrizione / Description			Rev.
	1732012442		DES PDM 24/42			003
	Materiale / Material	Colore / Color	Peso / Weight (g)	Unità di misura / Measure units	Formato / Format	Scala / Scale
See table	Grey	-	mm	A4	1:1	
 www.detasultra.com <small>QUESTO DISEGNO E LE SUE INFORMAZIONI SONO STRETTAMENTE RISERVATE DI PROPRIETÀ DETAS SPA. NON UTILIZZARE PER SCOPI DIVERSI DA QUELLI PER CUI SONO STATE FORNITE. DO NOT SCALE DRAWING.</small>			Data / Date	Numero foglio / Sheet number	Numero progetto / Project number	
			22/11/2021	-	-	
			Disegn. / Drawn	Note / Notes		
			ravezzano@detas.com	-		

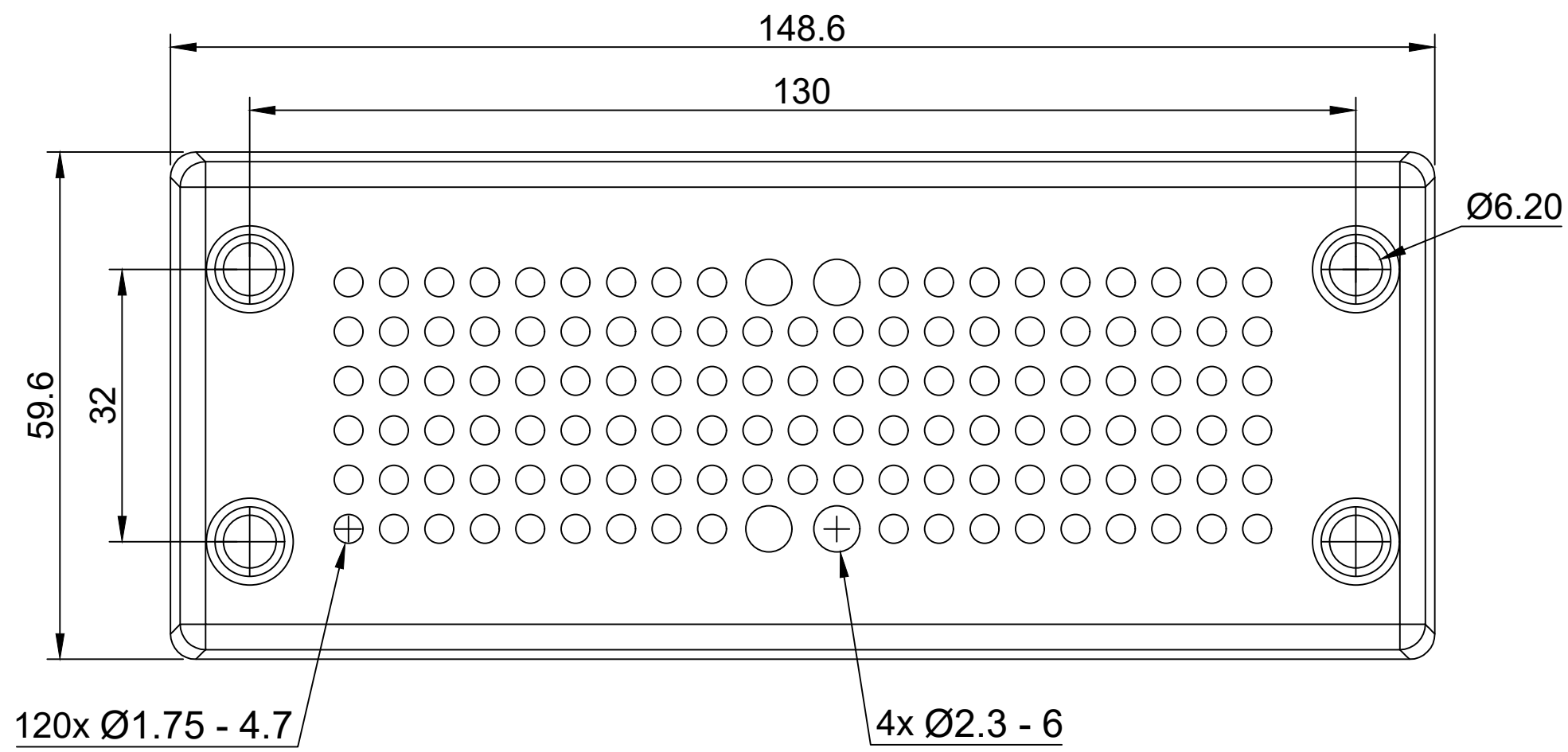
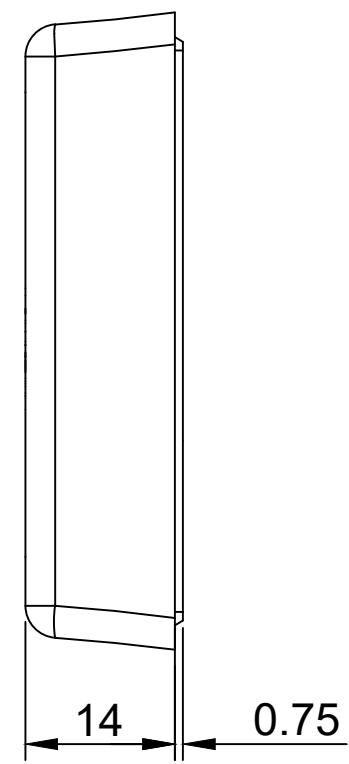
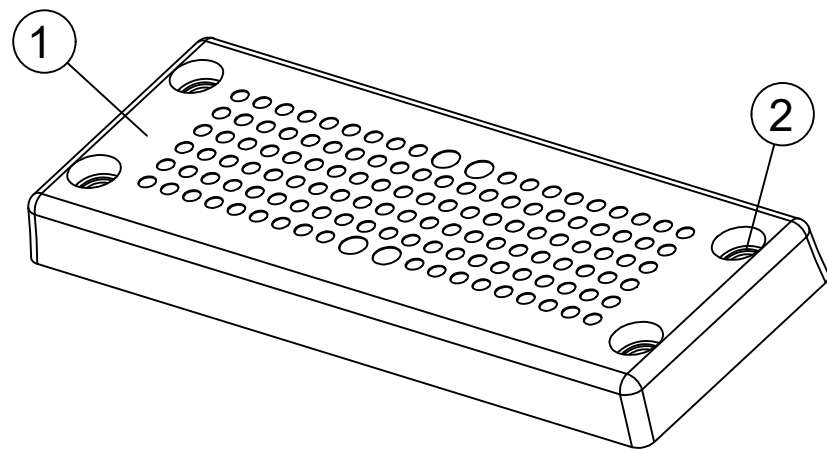

Id	Description	Material	Q.ty
1	Body	TPE	1
2	Internal frame	PA	1

Flammability: UL94-V0, self-extinguishing
Temperature: -40°C ... +105°C
Properties: halogen-free, silicone-free

Black color version:
 DES-PDM-24/14B: 1732052075

Threaded inserts version:
 DES-PDM-24/124G FT: 1732213421

ATEX grey version:
 DES-PDM-24A/124G: 1732312445

	IP66	NEMA 12, 4X	UL TYPE 12, 4X			ECOLAB			RoHS COMPLIANT	
--	-------------	--------------------	-----------------------	--	--	---------------	--	--	-----------------------	--

Recommended cut-out:
 112 x 36 mm

Codice / Code		Descrizione / Description				Rev.
1732050075		DES PDM 24/124				000
Materiale / Material	Colore / Color	Peso / Weight (g)	Unità di misura / Measure units	Formato / Format	Scala / Scale	
See table	Grey	-	mm	A4	1:1	
 www.detasultra.com			Data / Date	Numero foglio / Sheet number	Numero progetto / Project number	
			06/10/2022	-	-	
Disegn. / Drawn			Note / Notes			
Pozzi F.			-			

QUESTO DISEGNO E LE SUE INFORMAZIONI SONO STRETTAMENTE RISERVATE DI PROPRIETA' DETAS SPA. NON UTILIZZARE PER SCOPI DIVERSI DA QUELLI PER CUI SONO STATE FORNITE. DO NOT SCALE DRAWING.