

Recommended cut-out:  
112 x 39 mm

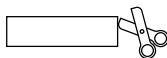

**Flammability:** UL94-V0, self-extinguishing  
**Temperature:** -40°C ... +155°C  
**Properties:** halogen-free, silicone-free

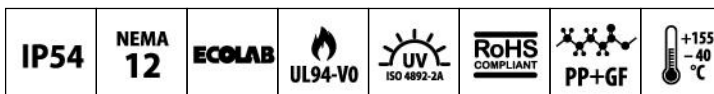

Codice / Code		1731032024			Descrizione / Description			DES COVER 24		Rev.	002
Materiale / Material		Spessore / Thickness		Peso / Weight (g)	Unità di misura / Measure units		Formato / Format	Scala / Scale			
PP + GF		-		-	mm		A4	1:1			
 www.detasultra.com <small>QUESTO DISEGNO E LE SUE INFORMAZIONI SONO STRETTAMENTE RISERVATE DI PROPRIETA' DETAS SPA. NON UTILIZZARE PER SCOPI DIVERSI DA QUELLI PER CUI SONO STATE FORNITE. DO NOT SCALE DRAWING.</small>					Data / Date		Numero foglio / Sheet number		Numero progetto / Project number		
					18/02/2021		-		-		
					Disegn. / Drawn		Note / Notes				
					ravezzano@detas.com		-				

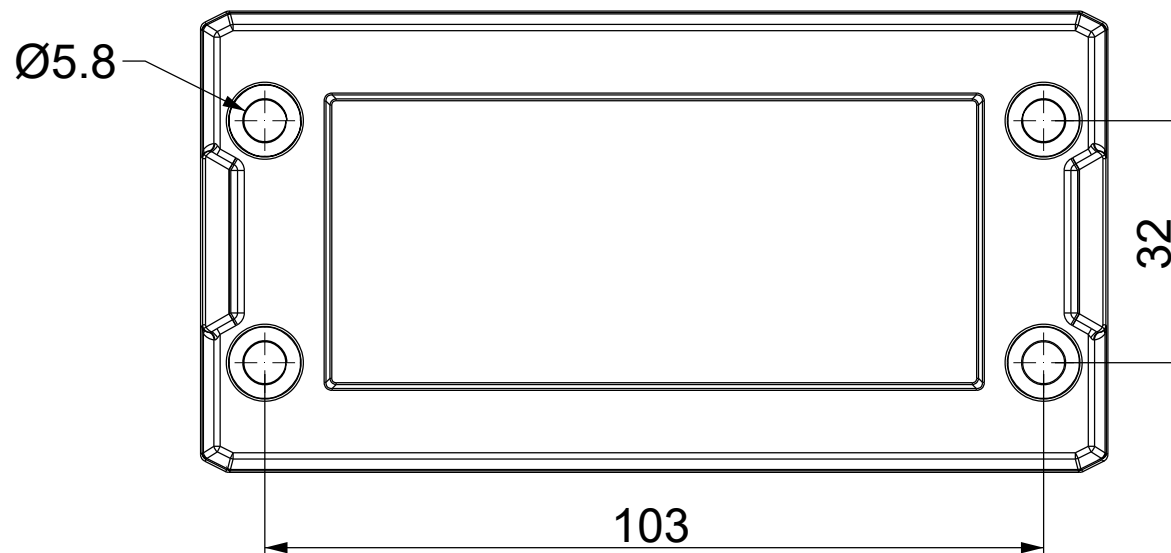
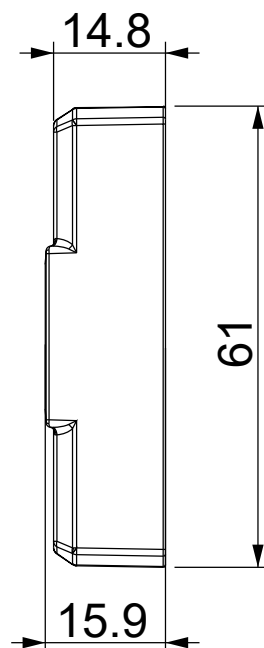
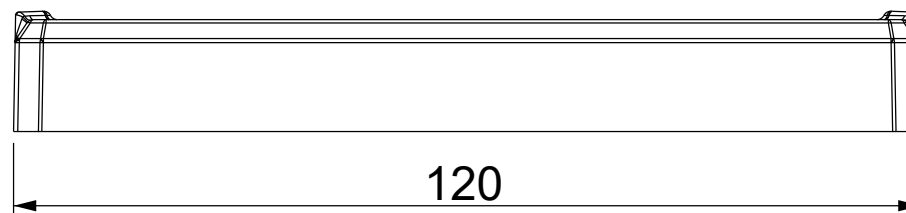
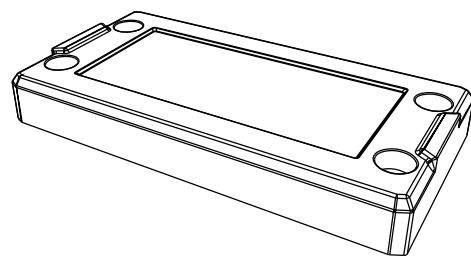

Recommended cut-out:  
86 x 39 mm

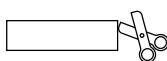

**Flammability:** UL94-V0, self-extinguishing  
**Temperature:** -40°C ... +155°C  
**Properties:** halogen-free, silicone-free



Codice / Code		1731032016			Descrizione / Description			DES COVER 16		Rev.	002
Materiale / Material		Spessore / Thickness		Peso / Weight (g)		Unità di misura / Measure units		Formato / Format	Scala / Scale		
PP + GF		-		-		mm		A4	1:1		
 www.detasultra.com <small>QUESTO DISEGNO E LE SUE INFORMAZIONI SONO STRETTAMENTE RISERVATE DI PROPRIETA' DETAS SPA. NON UTILIZZARE PER SCOPI DIVERSI DA QUELLI PER CUI SONO STATE FORNITE. DO NOT SCALE DRAWING.</small>		Data / Date		Numero foglio / Sheet number		Numero progetto / Project number					
		18/02/2021		-		-					
Disegn. / Drawn		Note / Notes									
ravezzano@detas.com		-									

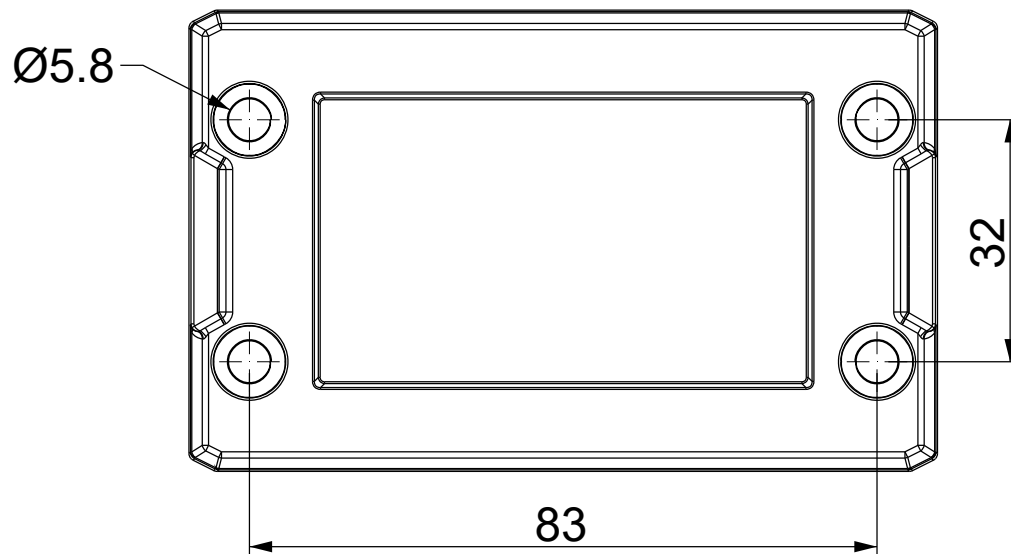
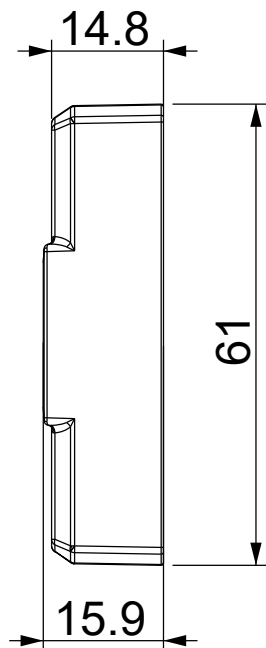
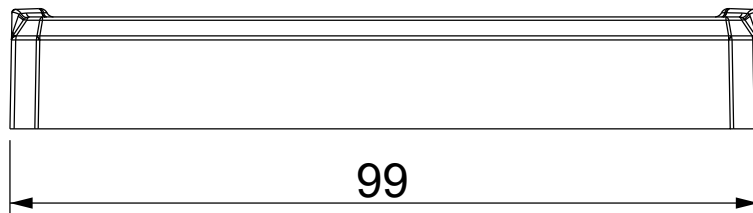
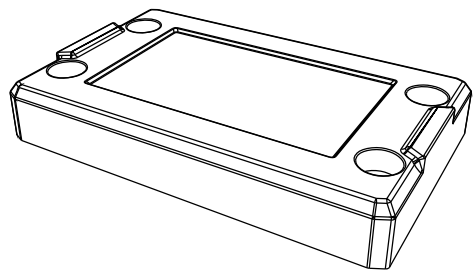

IP54	NEMA 12	ECOLAB	UL94-V0	UV ISO 4892-2A	ROHS COMPLIANT	PP+GF	+155 -40 °C
------	---------	--------	---------	----------------	----------------	-------	-------------------

Recommended cut-out:  
63 x 39 mm

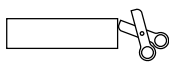

Codice / Code <b>1731032010</b>			Descrizione / Description <b>DES COVER 10</b>			Rev. 002
Materiale / Material PP + GF	Spessore / Thickness -	Peso / Weight (g) -	Unità di misura / Measure units mm	Formato / Format A4	Scala / Scale 1:1	UNI-ISO 2768-mK
 <b>DETASULTRA</b> <a href="http://www.detasultra.com">www.detasultra.com</a> <small>QUESTO DISEGNO E LE SUE INFORMAZIONI SONO STRETTAMENTE RISERVATE DI PROPRIETA' DETAS SPA. NON UTILIZZARE PER SCOPI DIVERSI DA QUELLI PER CUI SONO STATE FORNITE. DO NOT SCALE DRAWING.</small>			Data / Date 18/02/2021	Numero foglio / Sheet number -	Numero progetto / Project number -	
			Disegn. / Drawn ravezzano@detas.com	Note / Notes -		

**Flammability:** UL94-V0, self-extinguishing  
**Temperature:** -40°C ... +155°C  
**Properties:** halogen-free, silicone-free

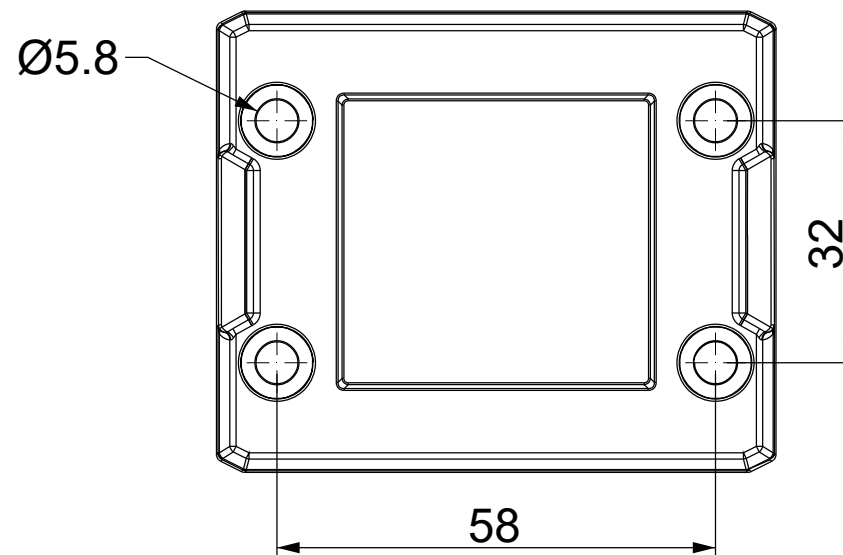
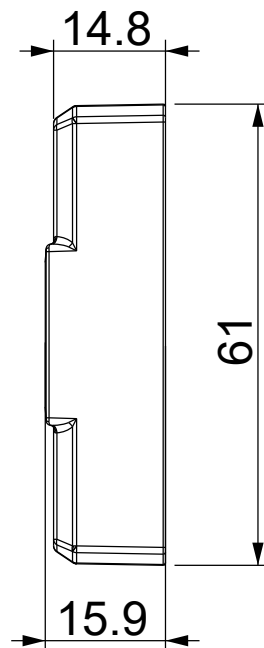
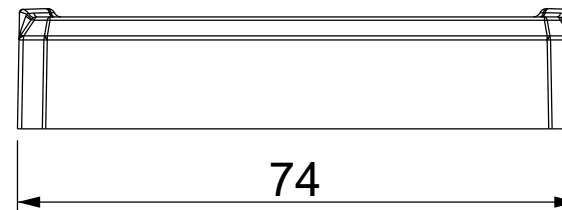
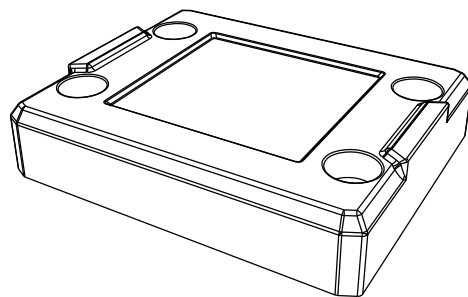

Recommended cut-out:  
40 x 39 mm

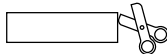

**Flammability:** UL94-V0, self-extinguishing  
**Temperature:** -40°C ... +155°C  
**Properties:** halogen-free, silicone-free

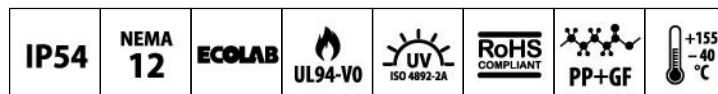

Codice / Code		1731032008			Descrizione / Description			DES COVER Q		Rev.	002
Materiale / Material		Spessore / Thickness		Peso / Weight (g)		Unità di misura / Measure units		Formato / Format	Scala / Scale		
PP + GF		-		-		mm		A4	1:1		
 www.detasultra.com <small>QUESTO DISEGNO E LE SUE INFORMAZIONI SONO STRETTAMENTE RISERVATE DI PROPRIETA' DETAS SPA. NON UTILIZZARE PER SCOPI DIVERSI DA QUELLI PER CUI SONO STATE FORNITE. DO NOT SCALE DRAWING.</small>					Data / Date		Numero foglio / Sheet number		Numero progetto / Project number		
					18/02/2021		-		-		
					Disegn. / Drawn		Note / Notes				
					ravezzano@detas.com		-				