

ROBOTRAX® System

Cable carrier for
3D movements



Trademarks are legally protected for the TSUBAKI KABELSCHLEPP GmbH
as a national or international registration in the following countries:
tsubaki-kabelschlepp.com/Trademarks

Subject to change.

ROBOTRAX® System | Overview

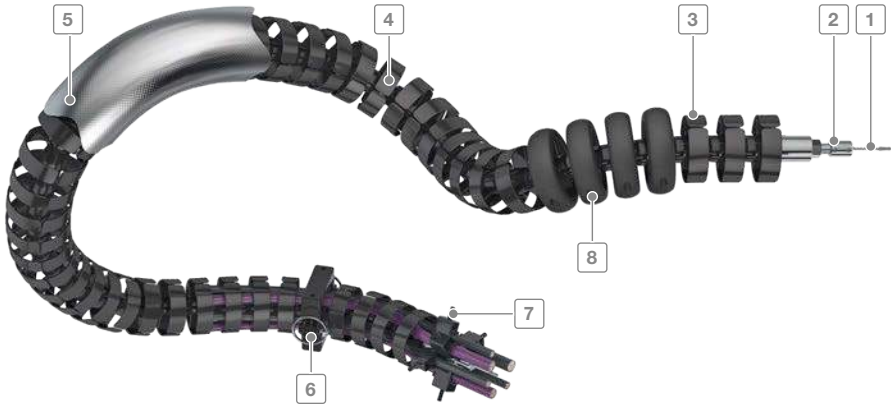

Inner heights

10
31

Inner widths

27
64

tsubaki-kabelschlepp.com/
robotrax

- 1 Steel cable for transferring extremely high tensile forces
- 2 Tension piece for locking the chain links
- 3 Special plastic for long service life
- 4 Open design
 - Fast cable laying as the cables are simply pressed in
 - Easy checking of all cables
- 5 Protective covers or heat shields made from different materials are available for different environmental conditions
- 6 Quick-release bracket for fixing and continuation
- 7 Strain relief with LineFix clamps
- 8 Protection against hard impacts, excessive abrasion and premature wear as well as limitation of the bending radius through protector

Features

- Suitable for three-dimensional swivel and rotation movements
- Ideal for a long service life of the cables:
 - The bending radius does not fall below the minimum
 - The cables can be separated in three chambers
- Also ideal for turntables



Quick-release brackets on turntable



Active return mechanism with the PBU pull back unit



Fast cable laying by simply pressing in the cables







Strain relief for secure fixing of the cables

Key for abbreviations
 on page 16

 Design guidelines
 from page 62

 Technical support:
technik@kabelschlepp.de
online-engineer.de
 Cable Carrier Configurator

Type	Opening variant	h_i [mm]	B_i [mm]	D_a [mm]	t [mm]	KR [mm]	Radial link rotation [°]	Additional load ≤ [kg/m]	Cable- d_{max} [mm]	Page
R040										
		10	27	40	21.5	70 [75]	± 450	0,7	8,5	580
R056										
		14	39	56	32	90 [105]	± 300	1,1	11	580
R075										
		22	52	75	40	125 [140]	± 215	4	18	580
R085										
		24	54	85	40	130 [170]	± 215	5	20	580
R100										
		31	64	100	40	130 [175]	± 215	6	27	580

Values in [] apply when using protectors

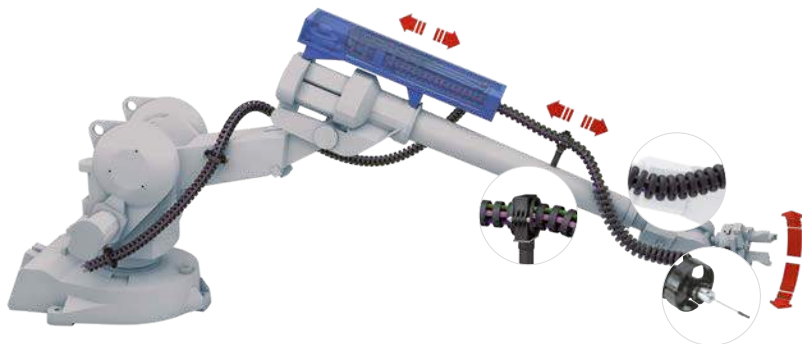

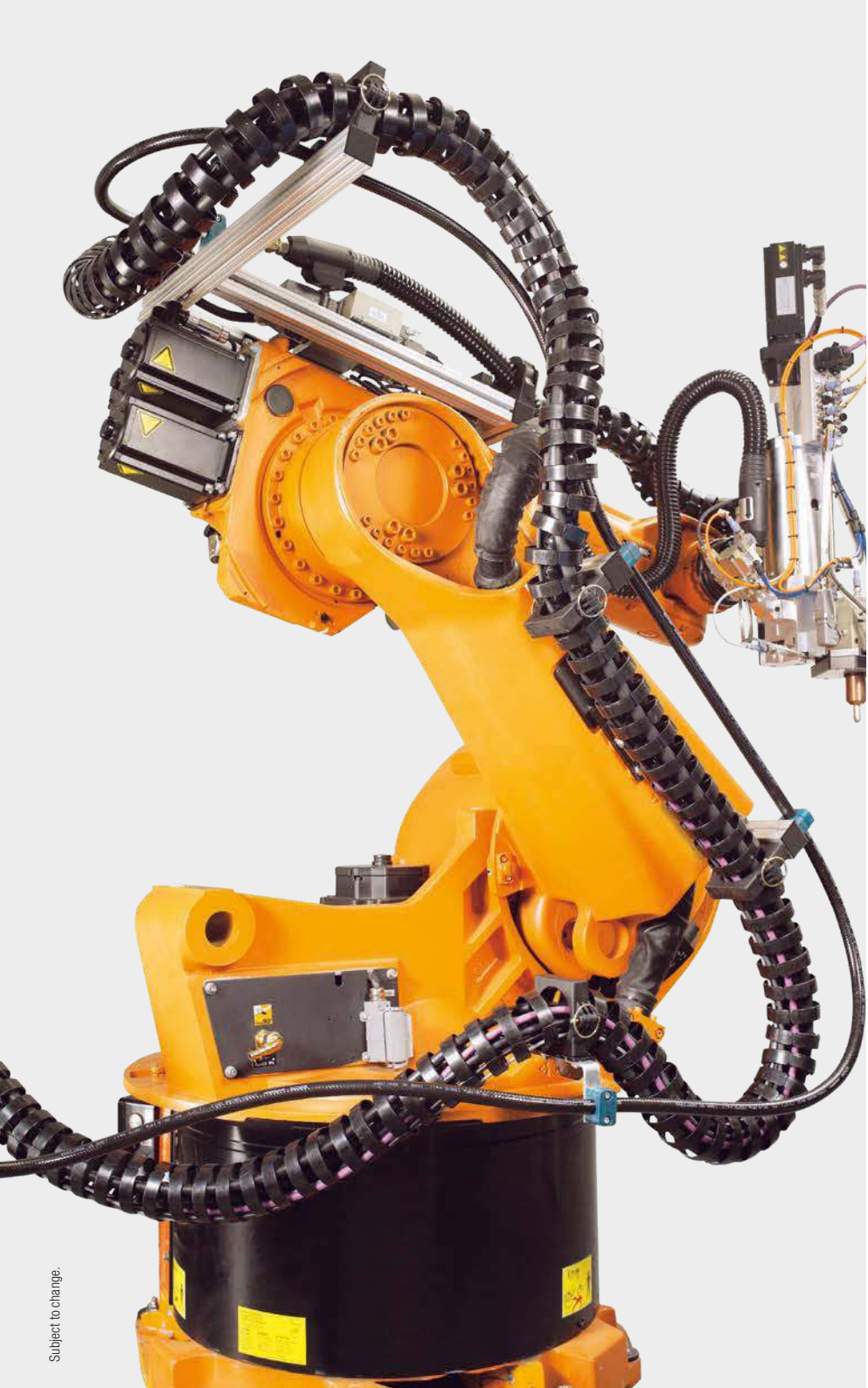

Subject to change.

ROBOTRAX®
system

Inner
heights



Inner
widths



tsubaki-kabelschlepp.com/
robotrax

ROBOTRAX®

Key for abbreviations
on page 16



Pitch
21.5 – 40 mm



Inner heights
10 – 31 mm



Inner widths
27 – 64 mm



Bending radii
80 – 195 mm

Chain links

The basic structure of ROBOTRAX® consists of plastic links. These have spherical snap-on connections on both sides. This allows the individual links to be snapped together to form a cable carrier.

Protectors ensure that the bending radius does not fall below the minimum in any direction. The links can be rotated in the radial direction (see table values). The cables can be separated in three chambers.



Design guidelines
from page 62

Technical support:
technik@kabelschlepp.de

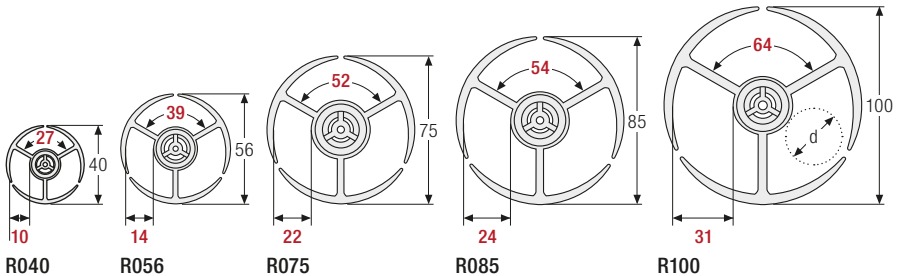

Dimensions and order

Type	t [mm]	KR [mm]	Radial rotation possible on 1 m length [°]	d [mm]	Number of links per m
R040	21.5	70 [75]	± 450	2 – 8.5	47
R056	32	90 [105]	± 300	2 – 11	31
R075	40	125 [140]	± 215	3 – 18	25
R085	40	130 [170]	± 215	3 – 20	25
R100	40	130 [175]	± 215	3 – 27	25

Values in [] apply when using protectors

Order example



* Type 010: cables are simply pressed in

Calculating the cable carrier length

Cable carrier length L_k

$$L_k = n \times t$$

Subject to change.

Steel cable, clamping and tension piece

Fast movements of the robot arms generate high accelerations and therefore high tensile forces on the cable carrier.

To transfer these tensile forces, ROBOTRAX® has a hole at the center of each chain link through which the steel cable is pulled. This steel cable takes on the function of force transmission.

The steel cable is fixed with a clamping piece on both sides. ROBOTRAX® permits accelerations up to 10 g.

The clamping piece can be used to easily set the chain links to the desired tension and adjust them at any time.

Long service life of the cables and hoses:

The forces are primarily transmitted by the cable carrier and not by cables and hoses.



Dimensions

	R040	R056	R075	R085	R100
Ø cable [mm]	1.8	2.5	3.0	3.0	4.0

Inner heights



Inner widths



Quick-release brackets

The ROBOTRAX® is fixed and continued with quick-release brackets which are attached with two screws.

The quick-release brackets fit on any chain link of the respective size. This means the fixing points can be individually adjusted to the motion sequence.

Quick opening:

Simply unlock, pull out and open the quick-release bracket.



Dimensions and order

	R040	R056	R075	R085	R100
h_1 [mm]	54	70	86	105	120
l_1 [mm]	15	22	28	30	32
b_1 [mm]	82	86	110	133	150
b_2 [mm]	50	63	82	96	112
b_3 [mm]	36	48	64	72	70
b_4 [mm]	18	24	32	36	35

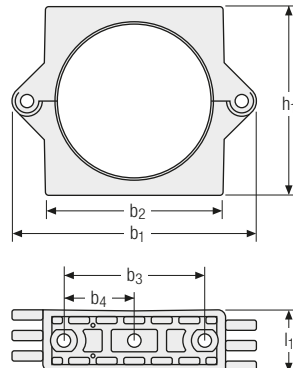

Threaded joint on the quick-release bracket:

R040, R056 with hexagon socket screws M4
 R075 with hexagon socket screws M6
 R085, R100 with hexagon socket screws M8

Key for abbreviations
on page 16

Heat shield/protective cover

Heat shield: The heat shield made from aluminum-coated textile fibers protects the ROBOTRAX® system and inserted cables against flying sparks, weld spatter and radiated heat.

Protective cover: The protective cover made from coated polyester protects against aggressive cutting fluids, hydraulic oils, fine dust and paint spatter.

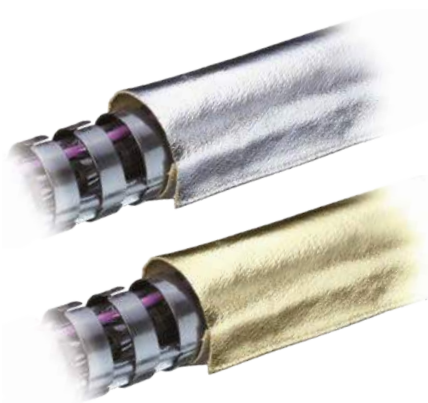

Please state when ordering.

Design guidelines
from page 62

Strain relief for cable ties

(available for all types)

For secure fixing of the cables.

The strain relief can be used on either end.



Please state when ordering.

Technical support:
technik@kabelschlepp.de

Strain relief LFR

(for types R075, R085 and R100)

Secure cable fixing, gentle on the cables.

Multi-layer cable fixing is also possible with double and triple LineFix® clamps. Several systems can be installed in sequence.

LineFix® strain reliefs – see page 796.



Please state when ordering.

PBU pull back unit/guide bracket

(available for all types)

PBU: With fast movement sequences and large work envelopes, the relatively long carriers knock against the robot arm. The repeated impact significantly reduces the service life of the cable carrier and the cables within, and the entire system can fail. Downtimes cause high costs and problems in the manufacturing process – so they have to be avoided.

 The PBU is available with a variety of different parameters. Please contact us.

Guide bracket: The guide bracket ensures a defined return into the PBU, with the ROBOTRAX® gliding through the bracket. This reliably prevents the cable carrier from knocking against the robot arm. Installation of the guide bracket is easy and quick. The bracket is easy to open and allows easy and fast cable laying. The guide bracket can be combined with the standard bracket and is available for all ROBOTRAX® sizes.

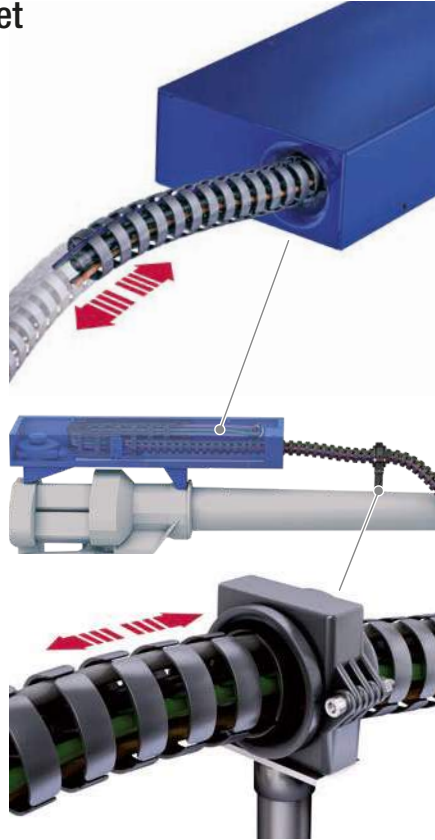

Inner heights

10
31

Inner widths

27
64

tsubaki-kabelschlepp.com/
robotrax

Protector

The service life of the cable carriers and cables is significantly reduced by impact during fast movement sequences and in large work envelopes. The Protector protects the cable carrier against hard impacts, excessive abrasion and premature wear, while also acting as a limitation for the smallest bending radius. Downtimes are minimized. Not the entire cable carrier has to be replaced, but only the Protector in some cases.

 Please state when ordering.



Turntable for quick-release bracket

One additional degree of freedom on the attachments points. When mounted on a turntable, the quick-release bracket can rotate as well, to offer increased flexibility during complex robot movements.



Dimensions

	R040	R056	R075	R085	R100
A [mm]	57	65	82	96	112
B [mm]	57	57	57	70	70
C [mm]	43	43	43	75	75
D [mm]	43	43	43	45	45
E [mm]	36	48	64	72	70
H [mm]	25	25	25	34	34
d ₁ [mm]	M6	M6	M6	M6	M6
d ₂ [mm]	M4	M4	M6	M8	M8

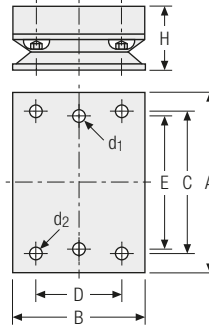

Set consisting of



Please state when ordering.

Coil spring for quick-release bracket

If the quick-release bracket is mounted on a coil spring, it can move elastically in all directions, deflect in 3 dimensions and spring back.



Dimensions

	R040	R056	R075	R085	R100
A [mm]	52	64	82	96	112
B [mm]	36	48	64	72	70
C [mm]	5	5	6.5	8.5	8.5
L [mm]	110	110	–	–	–
	150	150	–	–	–
	–	190	165	165	165
	–	–	230	230	230
	–	–	315	315	315
	–	–	465	465	465

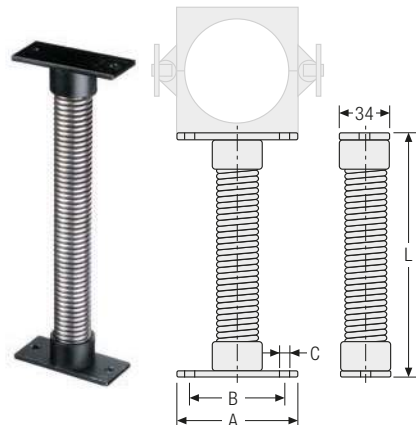

Please state when ordering.

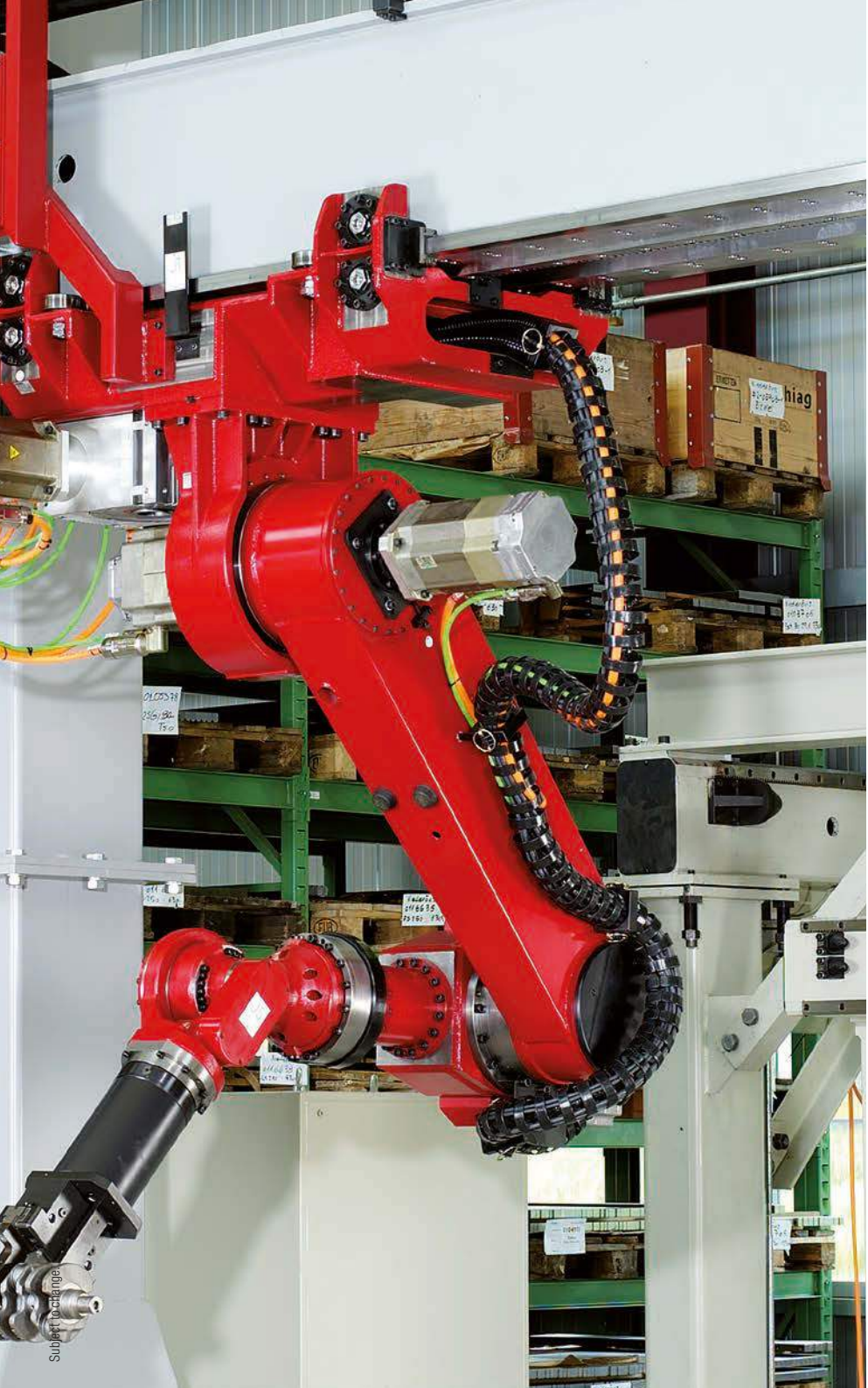

Subject to change

ROBOTRAX[®]
system

Inner heights



Inner widths



tsubaki-kabelschlepp.com/
robotrax