

QuickTrax® series

Compact and cost-effective
cable carriers in
two-component technology





Inner heights



Inner widths



tsubaki-kabelschlepp.com/quicktrax

- 1 Sturdy 2-component design: hard chain body, flexible film hinge
- 2 Plastic chain links
- 3 Extensive unsupported length
- 4 Inside space is gentle on the cables – no interfering edges
- 5 Very quiet through integrated noise damping
- 6 Quick and easy to open
- 7 Inside/outside openable
- 8 Dividers and height separations for cable separation
- 9 Single-part end connectors with and without integratable strain relief

Features

- Extremely fast and easy cable laying thanks to crossbar with film hinge
- Each chain link consists of two different materials:
 - Hard chain body made of glass-fibre reinforced material
 - Crossbar with flexible film hinge made of elastic special plastic
- Sturdy cable carrier design
- High torsional rigidity
- Very quiet through integrated noise damping
- Extensive unsupported length

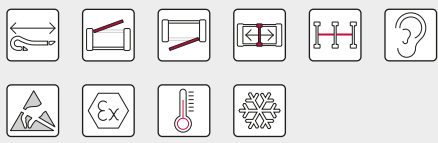

Easy to open...



...even without tools



High side stability



Reliable cable separation

Subject to change.

Key for abbreviations on page 16

Type	Opening variant	Stay variant	h _i [mm]	h _G [mm]	B _i [mm]	B _k [mm]	B _i -grid [mm]	t [mm]	KR [mm]	Additional load ≤ [kg/m]	Cable-d _{max} [mm]
QT0320											
		030	20	25.5	15-65	27-77	-	32	28-125	3	16
		040	20	25.5	15-65	27-77	-	32	28-125	3	16

Design guidelines from page 62

The two-component technology of the QT0320

The two-component technology of the **QT0320** combines two seemingly incompatible features: **Stability and flexibility.**

Cable carriers need to be extremely sturdy, with extensive unsupported length. At the same time, cables need to be inserted easily for fast cable laying.

The **QT0320** meets these requirements thanks to its innovative design and material combination of a hard cable carrier body made from glass fiber-reinforced material and crossbars with a film hinge made from rigid special plastic.

Technical support: technik@kabelschlepp.de

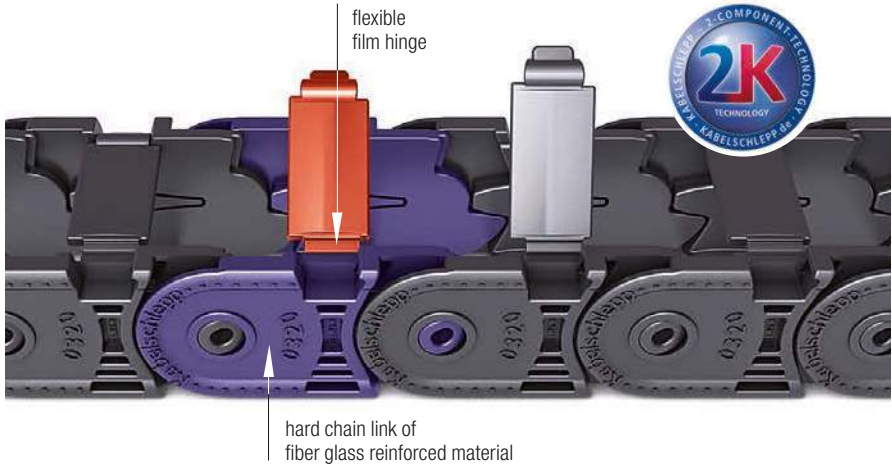
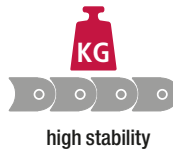
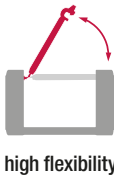

Unsupported arrangement			Gliding arrangement			Inner distribution				Installation variants			Page
Travel length ≤ [m]	$V_{max} \leq [m/s]$	$a_{max} \leq [m/s^2]$	Travel length ≤ [m]	$V_{max} \leq [m/s]$	$a_{max} \leq [m/s^2]$	TS0	TS1	TS2	TS3	vertical hanging or standing	lying on the side	rotating arrangement	
2.9	10	50	80	2.5	25	●	●	-	-	●	●	●	132
2.9	10	50	-	-	-	●	●	-	-	●	●	●	133

Inner heights



Inner widths



Comparison of dimensions

Manufacturer	h_i [mm]	h_G [mm]	t [mm]	Identical connection hole pattern
QT0320	20.0	25.5	32.0	ja
Competitive product	17.5	23.0	30.5	ja

Comparison of bending moment

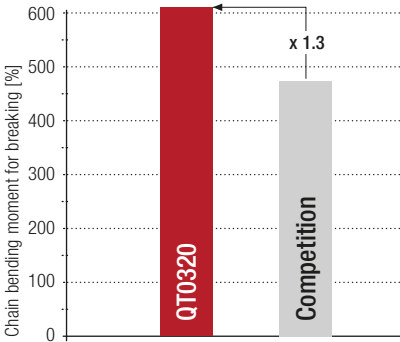

Comparison of bending strength

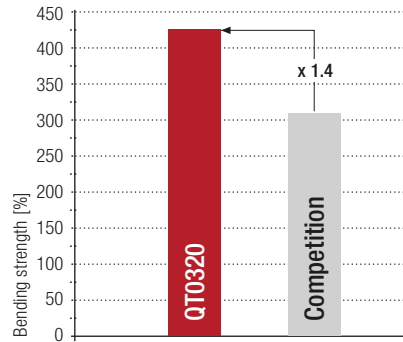

Advantages over competitive product

- 20 % longer unsupported length compared to competitive product
- 33 % greater additional load through use of fiber glass reinforced plastic
- Greater inner height
- Low noise operation due to internal damping system
- High side stability through locking in the stroke system
- Dividers can be used for cable separation

QT0320

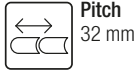
Key for abbreviations
on page 16Pitch
32 mmInner height
20 mmInner widths
15 – 65 mmBending radii
28 – 125 mm

Stay variants

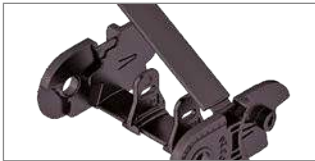
Design guidelines
from page 62**Design 030** page 132**Frame with outside opening crossbars**

- Weight-optimised plastic frame with particularly high torsional rigidity.
- Crossbar can be opened at any position on one side.
- **Outside:** openable.

**Design 040** page 133**Frame with inside opening crossbars**

- Weight-optimised plastic frame with particularly high torsional rigidity.
- Crossbar can be opened at any position on one side.
- **Inside:** openable.

Technical support:
technik@kabelschlepp.de

Unsupported arrangement

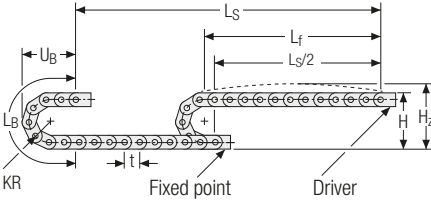

KR [mm]	H [mm]	H _z [mm]	L _B [mm]	U _B [mm]
28	81.5	101.5	152	73
38	101.5	121.5	184	83
48	121.5	141.5	215	93
75	175.5	195.5	300	120
100	225.5	245.5	379	145
125	275.5	295.5	457	170

Inner heights



Inner widths



Load diagram for unsupported length depending on the additional load.

Intrinsic cable carrier weight $q_k = 0.40$ kg/m with B₁ 38 mm. For other inner widths, the maximum additional load changes.

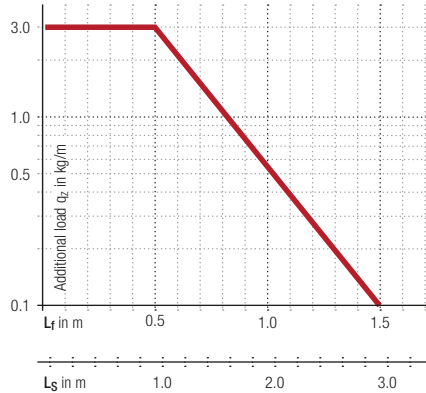

Speed
up to 10 m/s

Acceleration
up to 50 m/s²

Travel length
up to 2.9 m

Additional load
up to 3 kg/m

tsubaki-kabelschlepp.com/
quicktrax

Gliding arrangement

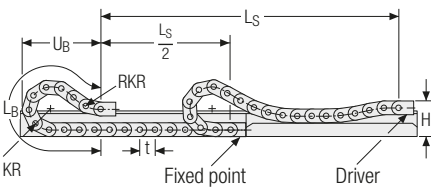

Speed
up to 2.5 m/s

Acceleration
up to 25 m/s²

The gliding cable carrier must be guided in a channel. See p. 732.

Only design 030 can be used for a gliding arrangement.

Travel length
up to 80 m

Additional load
up to 3 kg/m

Stay variant 030 –
with outside opening crossbars

- Weight-optimised plastic frame with particularly high torsional rigidity.
- Crossbars can be opened at any position on one side
- **Outside:** openable.



Key for abbreviations
on page 16



Stay arrangement on each chain link (VS: fully-stayed)



B_i 15 – 65 mm

Design guidelines
from page 62

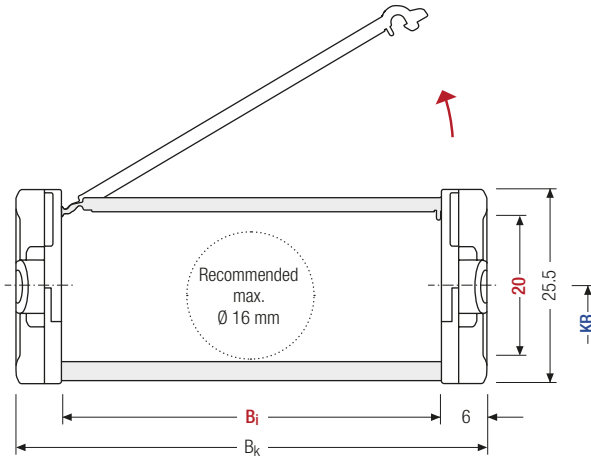

The maximum cable diameter strongly depends on the bending radius and the desired cable type. Please contact us.

Calculating the cable carrier length

Cable carrier length L_k

$$L_k \approx \frac{L_S}{2} + L_B$$

Cable carrier length L_k
rounded to pitch t

Technical support:
technik@kabelschlepp.de

h_i [mm]	h_G [mm]	B_i [mm]				B_k [mm]	KR [mm]				q_k [kg/m]			
20	25.5	15	25	38	50	65	$B_i + 12$	28	38	48	75	100	125	0.35 – 0.45

Order example

QT0320 ·
 030 ·
 50 ·
 100 ·
 1,280 ·
 VS
 Type Stay variant B_i [mm] KR [mm] L_k [mm] Stay arrangement

Stay variant 040 – with inside opening crossbars

- Weight-optimised plastic frame with particularly high torsional rigidity.
- Crossbars can be opened at any position on one side
- **Inside:** openable.



Inner heights





Inner widths

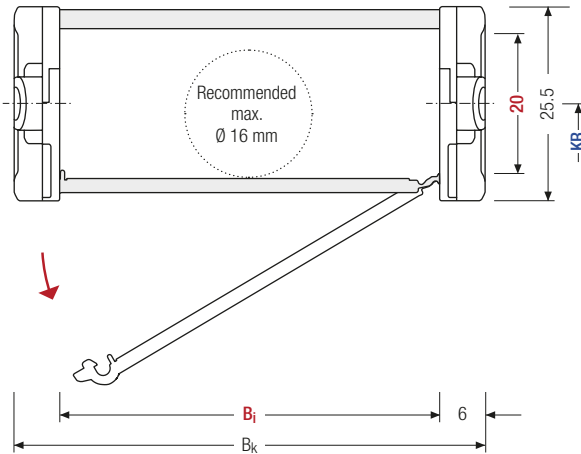

 Stay arrangement on each chain link (**VS: fully-stayed**)

 B_i 15 – 65 mm



 The maximum cable diameter strongly depends on the bending radius and the desired cable type. Please contact us.

Calculating the cable carrier length

Cable carrier length L_k

$$L_k \approx \frac{L_s}{2} + L_B$$

Cable carrier length L_k rounded to pitch t

tsubaki-kabelschlepp.com/
quicktrax

h_i [mm]	h_G [mm]	B_i [mm]		B_k [mm]	KR [mm]			q_k [kg/m]						
20	25.5	15	25	38	50	65	$B_i + 12$	28	38	48	75	100	125	0.35 – 0.45

Order example

 **QT0320** . **040** . **50** . **100** . **1.280** **VS**
 Type Stay variant B_i [mm] KR [mm] L_k [mm] Stay arrangement

Divider systems

The divider system is mounted on each crossbar as a standard – on every 2nd chain link for stay mounting (HS).

As a standard, dividers or the complete divider system (dividers with height separations) are movable in the cross section (**version A**).

Divider system TS0 without height separation

Vers.	a _T min [mm]	a _x min [mm]	a _c min [mm]	n _T min
A	4	8	6	–

The dividers can be moved in the cross section.

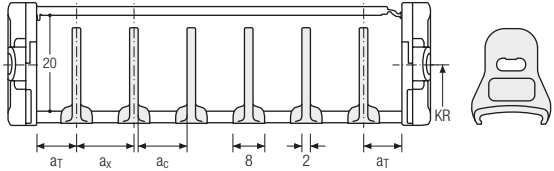

Divider system TS1 with continuous height separation

Vers.	a _T min [mm]	a _x min [mm]	a _c min [mm]	n _T min
A	4	8	6	2

The dividers can be moved in the cross section.

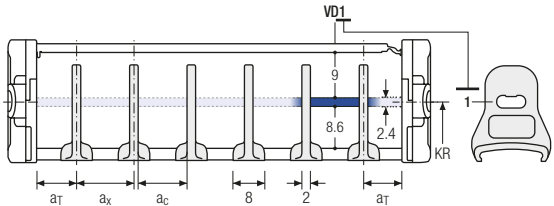

Order example

TS1 · A · 3 - V D 0
V D 1
 Divider system Version n_T Height separation

Please state the designation of the divider system (**TS0, TS1,...**), the version, and the number of dividers per cross section [n_T].

When using divider systems with height separation (**TS1**), please additionally state the position (e.g. VD1) viewed from the left driver belt. You are welcome to add a sketch to your order.



TRAXLINE® cables for cable carriers

Hi-flex electric cables which were specially developed, optimised and tested for use in cable carriers can be found at traxline.de.

QT0320 | End connectors

Single-part end connectors – plastic (with integrated strain relief)

The plastic end connectors can be connected **from above or below**. The connection type can be changed by altering the position of the end connector.

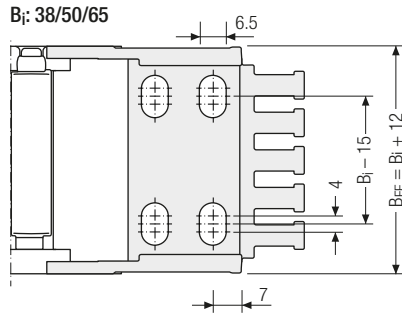
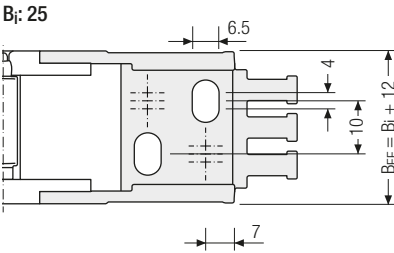
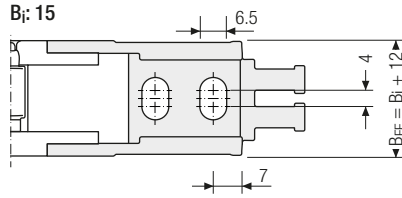
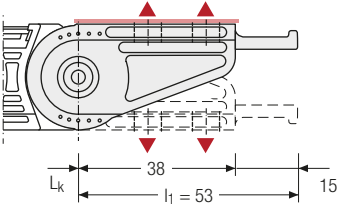

Inner heights



Inner widths



tsubaki-kabelschlepp.com/
quicktrax

▲ Assembly options

B_i [mm]	B_{EF} [mm]	n_z
15	27	2
25	37	3
38	50	4
50	62	5
65	77	6

The end connectors can not be swivelled.

The end connectors are also available as an option **without** integrated strain relief. Please state when ordering.

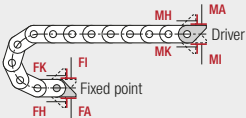

Connection point

- F – fixed point
- M – driver

Connection type

- A – threaded joint outside (standard)
- I – threaded joint inside
- H – threaded joint, rotated 90° to the outside
- K – threaded joint, rotated 90° to the inside

Order example

End connector . F A

End connector . M A

End connector Connection point Connection type