

MONO series

Cable carriers for
standard applications

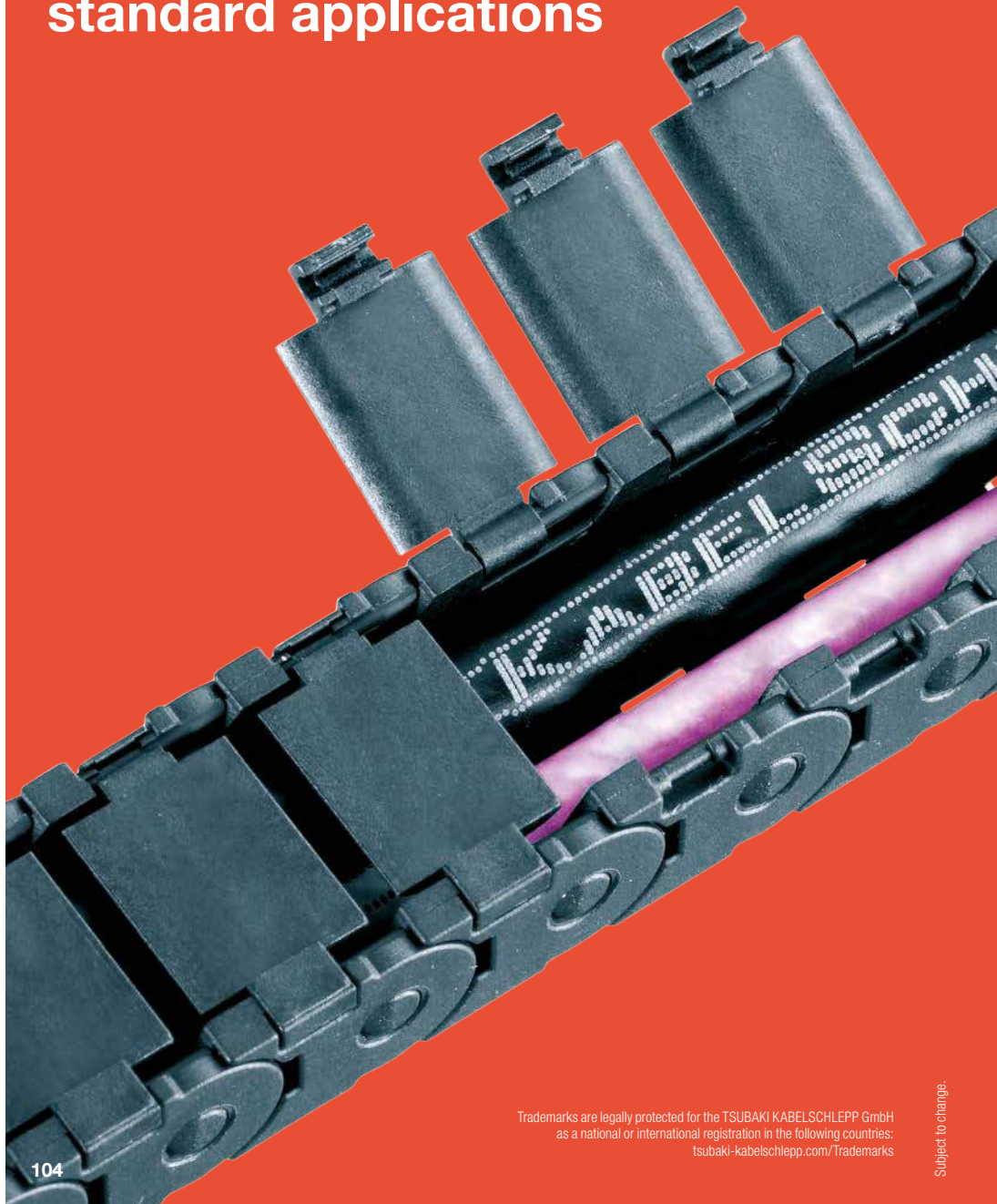

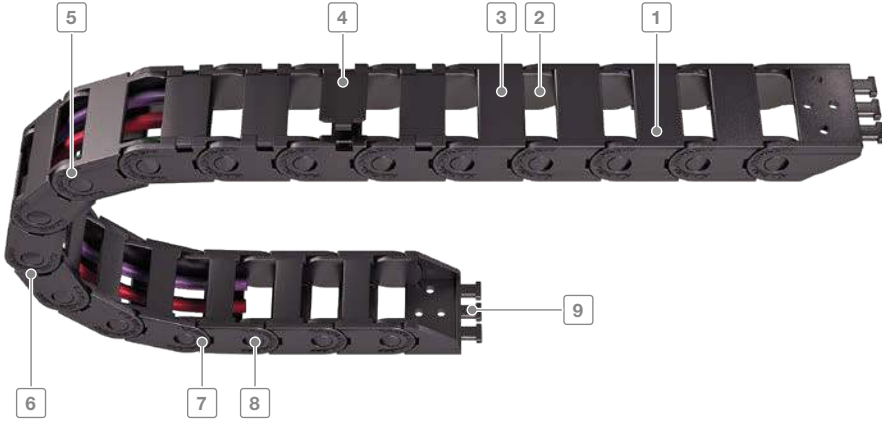

Inner heights



Inner widths



- 1 Plastic chain links
- 2 Inside space is gentle on the cables – no interfering edges
- 3 Types with single-part links
- 4 Types with opening crossbars
- 5 High torsional rigidity through large link surface
- 6 Extensive unsupported length and high additional loads through optimised stroke system
- 7 Easy to shorten and extend
- 8 Long service life through large bolt hole connection
- 9 End connectors with integrated strain relief

tsubaki-kabelschlepp.com/
mono

Features

- Cost-effective cable carrier
- Easy and fast installation
- Many types available immediately ex-stock world wide
- Long service life
- Great unsupported lengths compared to the unit size
- High torsional rigidity
- Easy to install



Small types for narrow installation spaces



Fast shortening/extending with push-to-connect chain links



Different connection variants through simple reconnecting of the end connectors

Key for abbreviations on page 12

Design guidelines from page 60

Technical support: technik@kabelschlepp.de

online-engineer.de
Cable Carrier Configurator

Type	Opening variant	Stay variant	h_i [mm]	h_G [mm]	B_i [mm]	B_k [mm]	B_i - grid [mm]	t [mm]	KR [mm]	Additional load ≤ [kg/m]	Cable- d_{max} [mm]
MONO 0130/0132											
		0132	10	12.5	6–40	12–46	–	13	20–37	0.5	8
		0130	10	12.5	6–40	12–46	–	13	20–37	0.5	8
MONO 0180/0182											
		0182	15	18	10–40	18–48	–	18	28–50	1	12
		0180	15	18	10–40	18–48	–	18	28–50	1	12
MONO 0202											
		0202	11	15	6–20	13–27	–	20	18–50	1.2	8.5



Technical manual

Do you need more information on the MONO series?
Our technical manual with all information on configuring your cable carrier can be found at tsubaki-kabelschlepp.com/download.

MONO series | Overview

MONO series

Unsupported arrangement			Gliding arrangement			Inner Distribution				Installation variants			Page
Travel length \leq [m]	$v_{max} \leq$ [m/s]	$a_{max} \leq$ [m/s ²]	Travel length \leq [m]	$v_{max} \leq$ [m/s]	$a_{max} \leq$ [m/s ²]	TS0	TS1	TS2	TS3	vertical hanging or standing	lying on the side	rotating arrangement	
1.15	10	50	40	3	30	-	-	-	-	•	•	-	110
1.15	10	50	40	3	30	-	-	-	-	•	•	-	111
1.55	10	50	70	3	30	-	-	-	-	•	•	-	116
1.55	10	50	70	3	30	-	-	-	-	•	•	-	117
1.95	10	50	70	3	30	-	-	-	-	•	•	•	122

Inner heights



Inner widths



tsubaki-kabelschlepp.com/mono

0130/0132

Key for abbreviations
on page 12

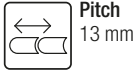

Pitch
13 mm



Inner height
10 mm

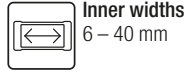

Inner widths
6 – 40 mm

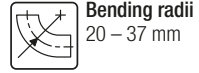

Bending radii
20 – 37 mm

Types



Type 0132 page 110

Closed frame (design 020)

- Weight optimised, closed plastic frame with high torsional rigidity.
- **Outside/inside:** not openable.



Type 0130 page 111

Frame with outside opening crossbars (design 030)

- Weight optimised plastic frame with high torsional rigidity.
- Openable at any position.
- **Outside/inside:** openable.

Design guidelines
from page 60

Technical support:
technik@kabelschlepp.de

Unsupported arrangement

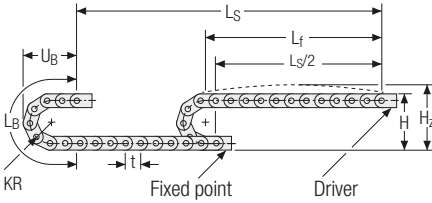

KR [mm]	H [mm]	H _z [mm]	L _B [mm]	U _B [mm]
20	52.5	62.5	89	40
28	68.5	78.5	114	48
37	86.5	96.5	142	57

Inner heights



Inner widths



Load diagram for unsupported length depending on the additional load.

Sagging of the cable carrier is technically permitted for extended travel lengths, depending on the specific application.

Intrinsic cable carrier weight $q_k = 0.16 \text{ kg/m}$ with $B_1 15 \text{ mm}$. For other inner widths, the maximum additional load changes.

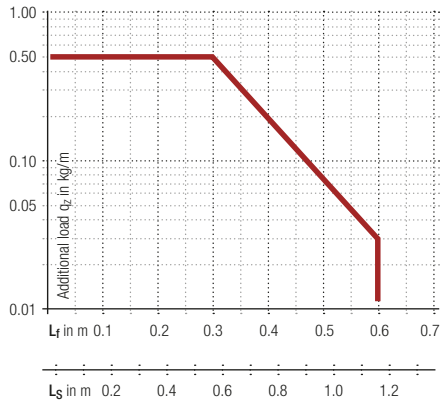

Speed
up to 10 m/s

Acceleration
up to 50 m/s²

Travel length
up to 1.15 m

Additional load
up to 0.5 kg/m

tsubaki-kabelschlepp.com/
mono

Gliding arrangement

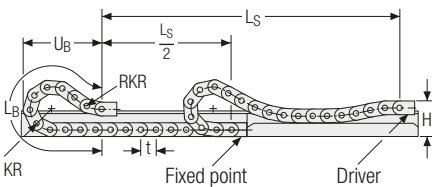

Speed
up to 3 m/s

Acceleration
up to 30 m/s²

The gliding cable carrier must be guided in a channel. See p. 702.

Travel length
up to 40 m

Additional load
up to 0.5 kg/m

Type 0132 – closed frame

- Weight optimised, closed plastic frame with high torsional rigidity.
- **Outside/inside:** not openable.



Key for abbreviations on page 12



Stay arrangement on each chain link (**VS: fully-stayed**)



B_i 6 – 40 mm

Design guidelines from page 60

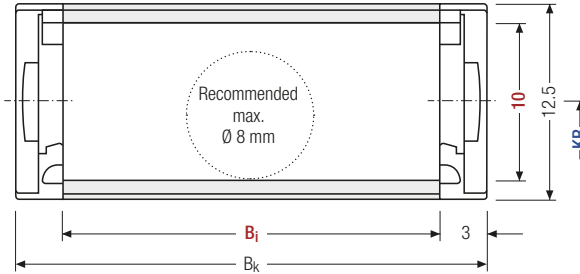

Recommended



The maximum cable diameter strongly depends on the bending radius and the desired cable type. Please contact us.

Calculating the cable carrier length

Cable carrier length L_k

$$L_k \approx \frac{L_S}{2} + L_B$$

Cable carrier length L_k rounded to pitch t

Technical support: technik@kabelschlepp.de

online-engineer.de
Cable Carrier Configurator

h_i [mm]	h_G [mm]	B_i [mm]				B_k [mm]	KR [mm]			q_k [kg/m]		
10	12.5	6	10	15	20	30*	40	$B_i + 6$	20	28	37	0.13 – 0.20

* On request

Order example

MONO
Series
·
0132
Type
·
15
B_i [mm]
·
28
KR [mm]
·
390
L_k [mm]
·
VS
Stay arrangement

Type 0130 – with outside opening crossbars

- Weight optimised plastic frame with high torsional rigidity.
- Openable at any position.
- **Outside:** openable.



Inner heights



Inner widths



Stay arrangement on each chain link (**VS: fully-stayed**)



B_i 6 – 40 mm

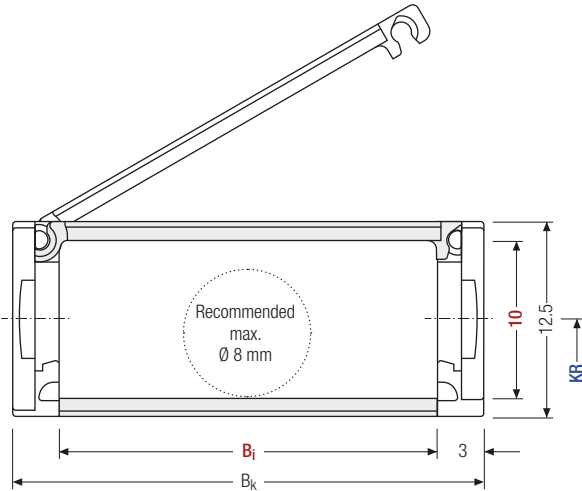

The maximum cable diameter strongly depends on the bending radius and the desired cable type. Please contact us.

Calculating the cable carrier length

Cable carrier length L_k

$$L_k \approx \frac{L_S}{2} + L_B$$

Cable carrier length L_k rounded to pitch t

h_i [mm]	h_G [mm]	B_i [mm]				B_k [mm]	KR [mm]			q_k [kg/m]	
10	12.5	6	10	15	20	40	$B_i + 6$	20	28	37	0.13 – 0.20

Order example



MONO (Series) ·
 0130 (Type) ·
 15 (B_i [mm]) ·
 28 (KR [mm]) ·
 390 (L_k [mm]) ·
 VS (Stay arrangement)

Key for abbreviations
on page 12

Design guidelines
from page 60

Technical support:
technik@kabelschlepp.de

online-engineer.de
Cable Carrier Configurator

Single-part end connectors – plastic (with integrated strain relief)

The plastic end connectors can be connected **from above or below**. The connection type can be changed by altering the position of the end connector.

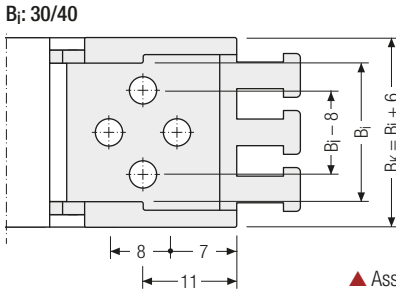
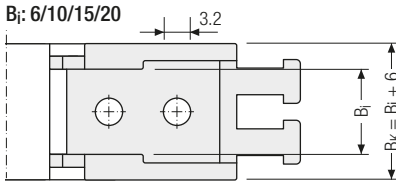
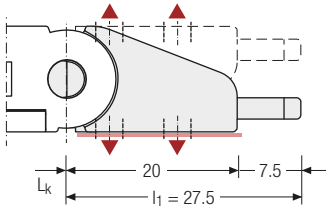

Single-part end connectors – plastic

The plastic end connectors can be connected **from above or below**. The connection type can be changed by altering the position of the end connector.

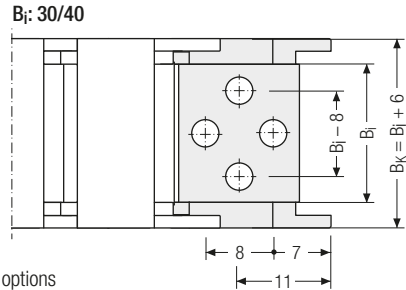
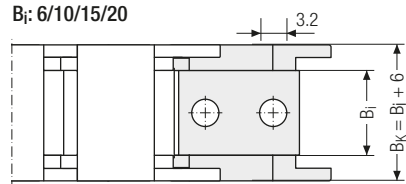
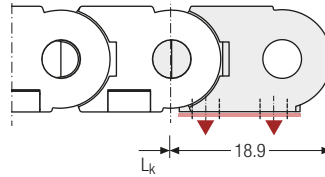

▲ Assembly options

Connection point

- F** – fixed point
- M** – driver

Connection type

- A** – threaded joint outside (standard)
- I** – threaded joint inside

Connection point

- F** – fixed point
- M** – driver

Connection type

- A** – threaded joint outside (standard)
- I** – threaded joint inside

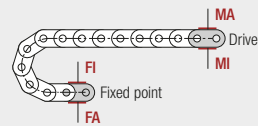
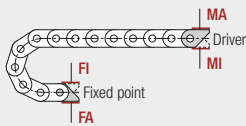

Order example

	End connector	.	F	A
	End connector	.	M	A
	End connector		Connection point	Connection type



Subject to change.

MONO
series

Inner
heights



Inner
widths



tsubaki-kabelschlepp.com/
mono

0180/0182

Key for abbreviations on page 12



Pitch
18 mm



Inner height
15 mm



Inner widths
10 – 40 mm



Bending radii
28 – 50 mm

Types

Design guidelines from page 60



Type 0182 page 116

Closed frame (design 020)

- Weight optimised, closed plastic frame with high torsional rigidity.
- **Outside/inside:** not openable.



Type 0180 page 117

Frame with outside opening crossbars (design 030)

- Weight optimised plastic frame with high torsional rigidity.
- Openable at any position.
- **Outside/inside:** openable.

Technical support: technik@kabelschlepp.de

Optimised cable carrier geometry:

Easy to shorten and extend

Long service life through large bolt hole connection



High torsional rigidity through large link surface

Extensive unsupported length and high additional loads through optimised stroke system

Unsupported arrangement

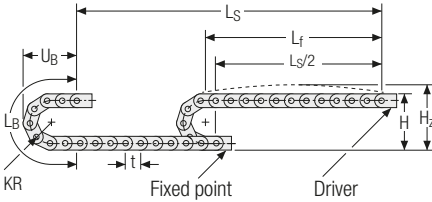

KR [mm]	H [mm]	H _z [mm]	L _B [mm]	U _B [mm]
28	74	89	124	55
37	92	107	153	64
50	118	133	194	77

Inner heights



Inner widths



Load diagram for unsupported length depending on the additional load.

Sagging of the cable carrier is technically permitted for extended travel lengths, depending on the specific application.

Intrinsic cable carrier weight $q_k = 0.25 \text{ kg/m}$ with $B_i 10 \text{ mm}$. For other inner widths, the maximum additional load changes.

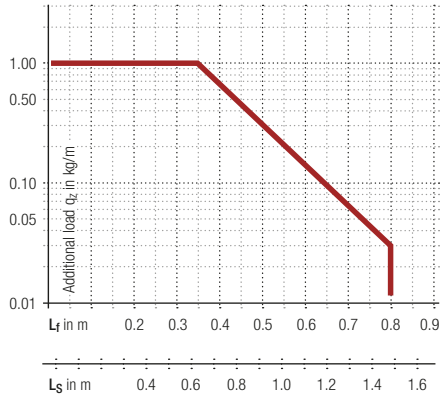

Speed
up to 10 m/s

Acceleration
up to 50 m/s²

Travel length
up to 1.5 m

Additional load
up to 1.0 kg/m

tsubaki-kabelschlepp.com/
mono

Gliding arrangement

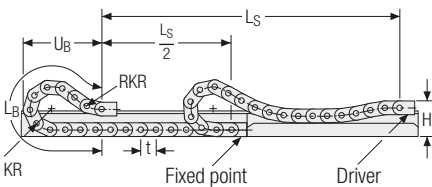

Speed
up to 3 m/s

Acceleration
up to 30 m/s²

The gliding cable carrier must be guided in a channel. See p. 702.

Travel length
up to 70 m

Additional load
up to 1.0 kg/m

Type 0182 – closed frame

- Weight optimised, closed plastic frame with high torsional rigidity.
- **Outside/inside:** not openable.



Key for abbreviations on page 12



Stay arrangement on each chain link (**VS: fully-stayed**)



B_i 10 – 40 mm

Design guidelines from page 60

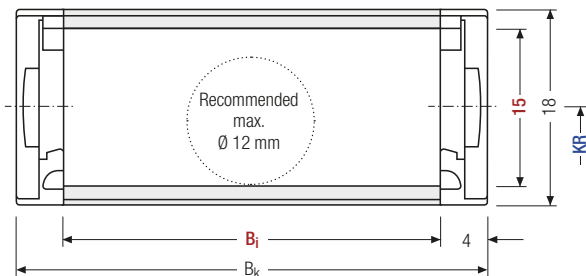

i The maximum cable diameter strongly depends on the bending radius and the desired cable type. Please contact us.

Calculating the cable carrier length

Cable carrier length L_k

$$L_k \approx \frac{L_s}{2} + L_B$$

Cable carrier length L_k rounded to pitch t

Technical support: technik@kabelschlepp.de

online-engineer.de
Cable Carrier Configurator

h_i [mm]	h_G [mm]	B_i [mm]			B_k [mm]	KR [mm]			q_k [kg/m]		
15	18	10	15	20	30	40	$B_i + 8$	28	37	50	0.23 – 0.30

Order example

MONO Series ·
 0182 Type ·
 30 B_i [mm] ·
 37 KR [mm] ·
 720 L_k [mm] ·
 VS Stay arrangement

Type 0180 – with outside opening crossbars

- Weight optimised plastic frame with high torsional rigidity.
- Openable at any position.
- **Outside:** openable.



Inner heights



Inner widths



Stay arrangement on each chain link (**VS: fully-stayed**)



B_i 10 – 40 mm

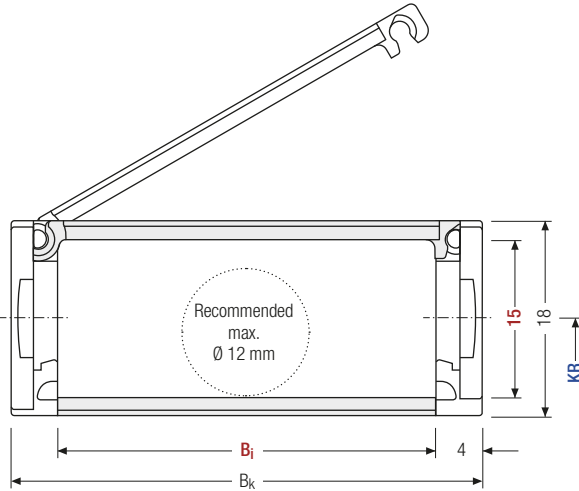

The maximum cable diameter strongly depends on the bending radius and the desired cable type. Please contact us.

Calculating the cable carrier length

Cable carrier length L_k

$$L_k \approx \frac{L_S}{2} + L_B$$

Cable carrier length L_k rounded to pitch t

tsubaki-kabelschlepp.com/
mono

h_i [mm]	h_G [mm]	B_i [mm]			B_k [mm]	KR [mm]			q_k [kg/m]		
15	18	10	15	20	30	40	$B_i + 8$	28	37	50	0.23 – 0.30

Order example

MONO
Series
0180
Type
30
 B_i [mm]
37
 KR [mm]
720
 L_k [mm]
VS
Stay arrangement

Key for abbreviations
on page 12

Design guidelines
from page 60

Technical support:
technik@kabelschlepp.de

online-engineer.de
Cable Carrier Configurator

Single-part end connectors – plastic (with integrated strain relief)

The plastic end connectors can be connected **from above or below**. The connection type can be changed by altering the position of the end connector.

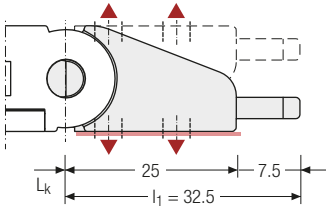

Single-part end connectors – plastic

The plastic end connectors can be connected **from above or below**. The connection type can be changed by altering the position of the end connector.

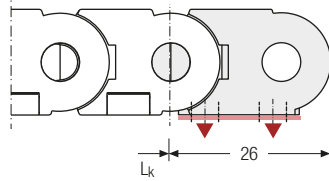

B_i: 10/15/20

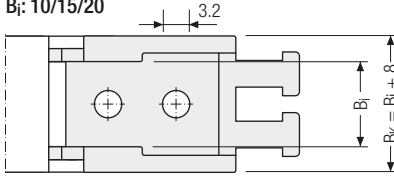

B_i: 10/15/20

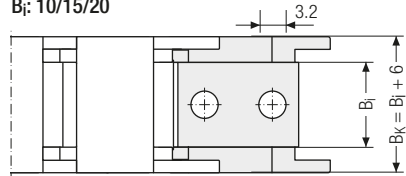

B_i: 30/40

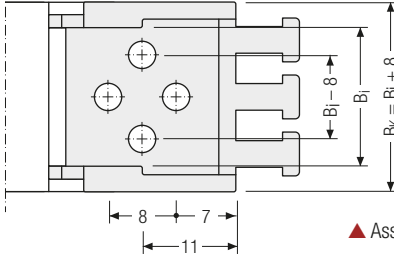

B_i: 30/40

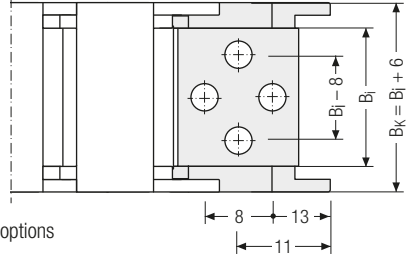

▲ Assembly options

Connection point

- F** – fixed point
- M** – Driver

Connection type

- A** – threaded joint outside (standard)
- I** – threaded joint inside

Connection point

- F** – fixed point
- M** – Driver

Connection type

- A** – threaded joint outside (standard)
- I** – threaded joint inside

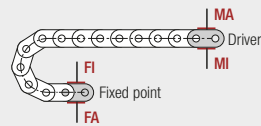
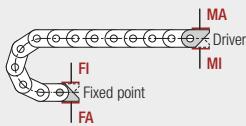

Order example

	End connector	.	F	A
	End connector	.	M	A
	End connector		Connection point	Connection type



Subject to change.

MONO
series

Inner heights



Inner widths



tsubaki-kabelschlepp.com/
mono

0202

Key for abbreviations on page 12



Pitch
20 mm



Inner height
11 mm



Inner widths
6 - 20 mm

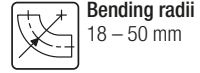

Bending radii
18 - 50 mm

Types



Type 0202 page 122

Closed frame (design 020)

- Weight optimised, closed plastic frame with high torsional rigidity.
- **Outside/inside:** not openable.

Design guidelines from page 60

Technical support: technik@kabelschlepp.de

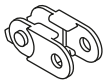

Fast cable laying – 0202 slotted version

The slotted variant of the MONO 0202 allows fast and easy pressing in of cables without opening the cable carrier. That saves time and therefore money. It is particularly suitable for cables with pre-assembled connectors. Please contact us!

online-engineer.de
Cable Carrier Configurator



Unsupported arrangement

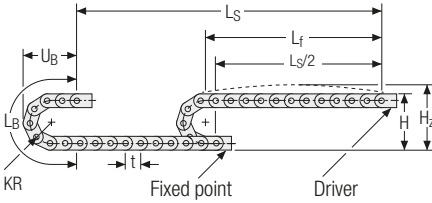

KR [mm]	H [mm]	H _z [mm]	L _B [mm]	U _B [mm]
18	51	61	97	45.5
28	71	81	128	55.5
38	91	101	160	65.5
50	115	125	198	77.5

Inner heights



Inner widths



Load diagram for unsupported length depending on the additional load.

Sagging of the cable carrier is technically permitted for extended travel lengths, depending on the specific application.

Intrinsic cable carrier weight $q_k = 0.18 \text{ kg/m}$ with $B_i 10 \text{ mm}$. For other inner widths, the maximum additional load changes.

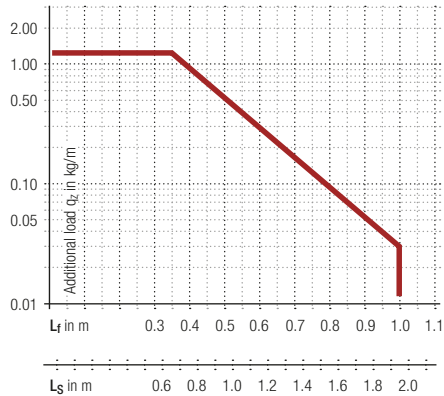

Speed
up to 10 m/s

Acceleration
up to 50 m/s²

Travel length
up to 1.95 m

Additional load
up to 1.25 kg/m

Gliding arrangement

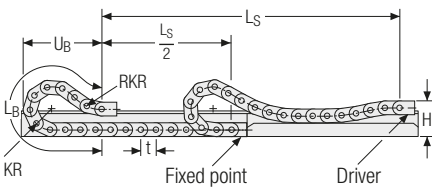

Speed
up to 3 m/s

Acceleration
up to 30 m/s²

The gliding cable carrier must be guided in a channel. See p. 702.

Travel length
up to 70 m

Additional load
up to 1.0 kg/m

Type 0202 – closed frame

- Weight optimised, closed plastic frame with high torsional rigidity.
- **Outside/inside:** not openable.



Key for abbreviations on page 12



Stay arrangement on each chain link (**VS: fully-stayed**)



B_i 6 – 20 mm

Design guidelines from page 60

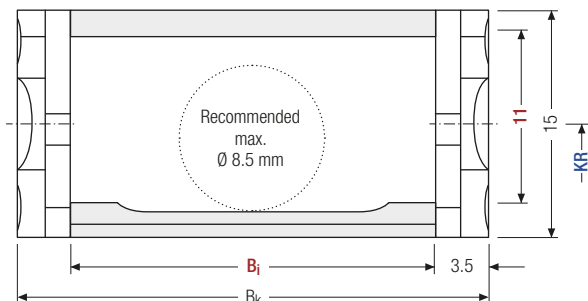

The maximum cable diameter strongly depends on the bending radius and the desired cable type. Please contact us.

Calculating the cable carrier length

Cable carrier length L_k

$$L_k \approx \frac{L_s}{2} + L_B$$

Cable carrier length L_k rounded to pitch t

Technical support: technik@kabelschlepp.de

h_i [mm]	h_G [mm]	B_i [mm]			B_k [mm]	KR [mm]				q_k [kg/m]	
11	15	6	10	15	20	$B_i + 7$	18	28	38	50	0.14 – 0.17

Order example



MONO
Series

0202
Type

10
 B_i [mm]

28
 KR [mm]

460
 L_k [mm]

VS
Stay arrangement

Single-part end connectors – plastic (with integrated strain relief)

The plastic end connectors can be connected **from above or below**. The connection type can be changed by altering the position of the end connector.

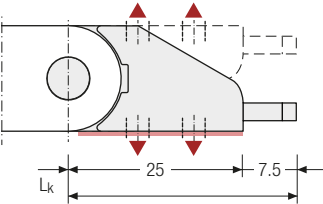

▲ Assembly options

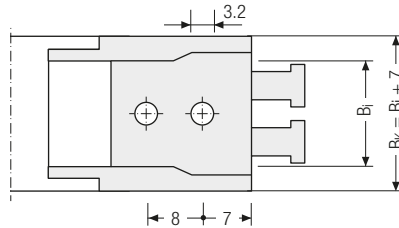

Inner heights



Inner widths



tsubaki-kabelschlepp.com/
mono

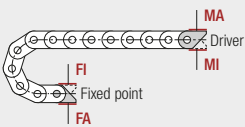

Connection point

F – fixed point
M – driver

Connection type

A – threaded joint outside (standard)
I – threaded joint inside

Order example

	End connector	.	F	A
	End connector	.	M	A
	End connector		Connection point	Connection type

Additional product information online



Installation instructions, etc.:
Additional info via your smartphone or check online at tsubaki-kabelschlepp.com/support



Configure your cable carrier here:
onlineengineer.de